

To Whom It May Concern:

Re: Curb, Sidewalk and Ditch Crossing Information Package

The following information package has been prepared as a guide for construction of sidewalk and curb crossings. It is not intended to be a complete listing of all City of Saskatoon (City) Specifications and Bylaws governing this construction.

All construction of City sidewalks and curbs requires prior approval by the Transportation and Construction (T&C) Department and must conform to City specifications. Approval is obtained when a sidewalk crossing permit has been issued.

Prior to pouring the sidewalk or curb crossing, it will be necessary to have the forms and site preparation inspected by a City Inspector and approved prior to placing any concrete.

The inspection may be arranged by calling (306) 986-9727 or by emailing drivewaypermits@saskatoon.ca.

GENERAL

All crossings construction shall conform to Bylaw No. 4785 as amended, which regulates the installation of boulevard crossings in the City of Saskatoon.

It shall be the Permit Holder's responsibility to construct the crossing in accordance with the City's current standard specifications and drawings. Pertinent drawings are attached to this letter. The entire package of standard specifications and drawings are available on the City's website.

A permit, available from T&C's Transportation Department (306-986-9727 or drivewaypermits@saskatoon.ca), **must** be obtained before work may start. Prior to issuing a permit, a representative from Transportation will meet with you on site to perform a pre-permit inspection. Current application fees are listed on the City's website.

For all commercial crossings, any crossing involving paid on-street parking, and new crossings where a property is presently serviced by an existing crossing(s), the Owner or Contractor shall submit with the application for permit two copies of the site layout to scale showing the size and location of the crossing or crossings. For all crossings, all trees, light standards, hydrants, and catch basins must be shown on the plan. Construction of concrete sidewalk, curb, or crossings may begin on or after May 15th and shall be terminated on or before October 1st, unless special permission is received from the Engineer, and section 06010-24 of the City's standard specifications is adhered.

SITE INSPECTIONS

When booking inspections please contact us two to three (2-3) business days in advance.

Prior to pouring the sidewalk or curb crossing, it will be necessary to have the concrete forms and base preparation inspected/approved by a City Inspector prior to placing any concrete.

Form inspections may be arranged by calling (306) 986-9727 or by emailing us at drivewaypermits@saskatoon.ca.

A final inspection shall be made after concrete is placed and finished. If the finish concrete is deemed sub-standard, the crossing will not be approved by the City Inspector and will have to be reconstructed by the Permit Holder.

Final concrete inspections may be arranged by calling (306) 986-9727 or by emailing us at drivewaypermits@saskatoon.ca

When construction is being done by a Contractor, it is recommended that the payment for the crossing be held until final inspection and approval is given by the City Inspector.

PEDESTRIAN AND VEHICLE EGRESS

The Permit Holder shall provide and maintain a safe work environment with all the necessary barricades, warning lights, or any other means of protection for the safety of the general public from commencement of the project, up to the completion of the work. The maximum time-period between removing and replacing concrete curb and sidewalk shall be no longer than three (3) working days.

LANE AND DRIVEWAY CROSSINGS

Sidewalk crossings shall have a concrete slab with a thickness of 180 mm (125 mm minimum for single-family dwellings), and the crossing wing shall vary in thickness, as indicated by the standards drawings. All crossings must conform to the current City of Saskatoon Specifications.

The sidewalk portion of the curb crossing shall not exceed 5% cross-slope, as measured from the back of walk to top-of-curb.

SEPARATE SIDEWALK AND CURB DRIVEWAYS

At the time of crossing construction, in areas where there is separate sidewalk and curb, the Permit Holder is responsible to concrete or pave the boulevard portion between the curb and sidewalk (granular material is unacceptable). Paving stones allow water penetration and may not be used in this area.

REDI-MIX CONCRETE

Concrete used shall be 32 MPa minimum 28 day compressive strength Dura-Mix concrete.

Slump shall be no greater than 80 mm. Air Entraining (AE) limits shall be between 5% and 8% of volume. Minimum Portland cement content shall be 285 kg/ m³. Minimum cementitious content shall be 330 kg/ m³

Concrete suppliers must be approved by the City of Saskatoon, in accordance with section 06005-3 of the City's standard construction specifications. Concrete placed without proper approvals may be subject to removal and replacement, at the expense of the Permit Holder. The Permit Holder must be prepared to supply proof that Dura-Mix concrete was delivered to the construction site and used for the sidewalk crossing.

METHOD OF REMOVING SIDEWALK AND CURB

Concrete will be removed to the nearest control joint. NO partial-panel replacement of sidewalk will be permitted. The ends of the concrete to be removed shall be cut at control joints with a concrete saw. The cut shall be of sufficient depth to permit removal without damage to the remaining structure.

FORMS

The forms used for each type of construction shall be the same as the dimensions on the drawings.

They shall be free from warps or other defects and shall have smooth, clean surfaces adjacent to the concrete. The forms shall be thoroughly cleaned and oiled before any concrete is deposited within them.

The forms shall be well staked, braced, and held rigidly to establish a consistent final grade line and free from obstructions, to enable the use of mechanical concrete vibrators and vibrator screeds while placing concrete.

GRADE CONSTRUCTION (GRAVEL BASE)

Grade construction using base gravel shall include excavation and disposal of in-situ soil to a depth of 150 mm below finished subgrade, with the placement of 150 mm of base gravel compacted to 98% standard proctor density at optimum moisture content. If the subbase or the base is spongy, or moves under a concentrated load, it shall be re-worked until hard and shows no movement.

DOWELS

Installation of 10M x 250 mm dowels is required when tying into existing concrete sidewalk or curb. These dowels must be galvanized, epoxy coated or stainless steel. The ends of each dowel shall have the same coating as the rest of the dowel. Three (3) dowels shall be installed evenly spaced across the walk; two (2) evenly spaced dowels shall be vertically installed in the curb, and one (1) dowel installed in the gutter, when present.

These dowels shall be installed at least 100 mm into the existing concrete, which will be placed in the center of the thickness of concrete (equally spaced between the top and bottom of the sidewalk/gutter panel thickness)

PLACING OF CONCRETE

Concrete shall be disposed in a manner to prevent segregation of the aggregate. Special care shall be taken in placing concrete to prevent voids, pockets, rough areas and honeycombing. The concrete shall be tamped by using mechanical concrete vibrators or vibrator screed in such a manner as to work the coarse aggregate away from the forms and exposed surfaces.

FINISH OF SIDEWALK, CURB AND GUTTER

After the concrete has sufficiently set to permit further finishing, without water bleeding, the surface shall be brought to a true surface with a wood float. The surface of sidewalk and face of curb shall be marked as shown on drawings using approved tools. After marking, the surface shall be troweled smooth with a steel trowel, and a uniform brush finish applied with a soft bristled push broom, to the satisfaction of the Engineer. After the initial concrete set, the curb form shall be removed and the exposed surface of the curb shall be worked to a true surface, control joint marked on face, troweled smooth, and then given a uniform brush finish.

CONCRETING IN SUB-NORMAL CONDITIONS

During cold weather, concrete may be placed when the air temperature in the shade is 1° C and rising. Concrete shall not be placed when the air temperature is 5° C and falling.

Freshly placed concrete shall be adequately covered and protected or heated to maintain a minimum temperature of 5° C for 36 hours. Covering is to be maintained for 72 hours. The cost of all heating and protection shall be borne by the Permit Holder. In no case shall concrete be deposited on or against any surface which is at a temperature of less than 5° C.

Concrete damaged by freezing shall be replaced at the Permit Holder's expense. All concrete pouring shall be terminated on or before October 31st, unless permission is received from the City's Engineer.

CONCRETE CURING

An approved curing compound shall be applied to the surface of the concrete (walk surface and curb face) immediately after the surface has been finished and broomed.

RAIN DAMAGE

Once concrete is placed and floated, the concrete will be rejected for the following reasons:

1. Any amount of rain falling on the surface
2. Water is sprinkled on the surface during finishing (before, during, or after trowelling or brooming).

Concrete that has been rejected shall be removed and replaced at the Permit Holder's expense.

CONCRETE PROTECTION

Concrete walk shall be allowed to set a minimum of twenty-four (24) hours before pedestrian traffic is permitted. Commercial and industrial lane crossings shall be barricaded for seven (7) days from vehicle traffic, and residential crossings shall be barricaded for five (5) days. Any work damaged within the time period specified shall be replaced at the Permit Holder's expense.

PAVEMENT PATCHING

Whenever a private crossing is constructed after the street is paved, the Permit Holder shall be responsible to patch the road surface to the satisfaction of the Engineer.

The area to be patch paved shall consist of City of Saskatoon Type 3 asphalt placed and compacted, over 20 MPa lean concrete.

PROVISIONAL FOR FUTURE SIDEWALK

When private driveways are constructed across the boulevard portion of the street, provision shall be made by the Permit Holder to meet the future sidewalk or street grade.

Any alterations to provide driveways shall be the Permit Holder's responsibility. Information may be obtained from T&C Department.

TYPICAL SIDEWALK AND CURB DRAWINGS

All drawings listed below can be found by visiting:

<https://www.saskatoon.ca/business-development/development-regulation/specifications-standards/drawings>

Attached Vertical Curb:

102-0002-006r004	Crossing, Walk, 150mm Vertical Curb & Gutter
102-0002-008r005	Crossing, Walk & 150mm Vertical Curb
102-0002-033r003	Combined Walk & Vertical Curb

Separate Vertical Curb:

102-0002-010r003	Crossing Separated Walk Vertical Curb & Gutter
102-0002-013r004	Curb Return Crossing Separate Walk, Vertical Curb
102-0002-017r003	Typical Driveway Curb Detail Isometric View
102-0002-003r001	Separate Dropped Curb Crossings
102-0002-005r003	Separate Vertical Curb
102-0002-001r004	Full Height Curbs and Gutters

Supporting Drawings:

102-0010-012r001	Typical Catch Basin Conversion at Driveway or Crossing
102-0002-049r003	Gutter Patch Paving
102-0002-021r001	Control Joints
102-0002-022r001	Dowel/Control Joint Location & Spacing
102-0018-009r003	Standard Ditch Crossing & Culvert Requirements

PLEASE NOTE: The drawings provided above are the most commonly used when installing a driveway crossing but will not cover all situations. The entire list of drawings are available on the following City Website:

<https://www.saskatoon.ca/business-development/development-regulation/specifications-standards>

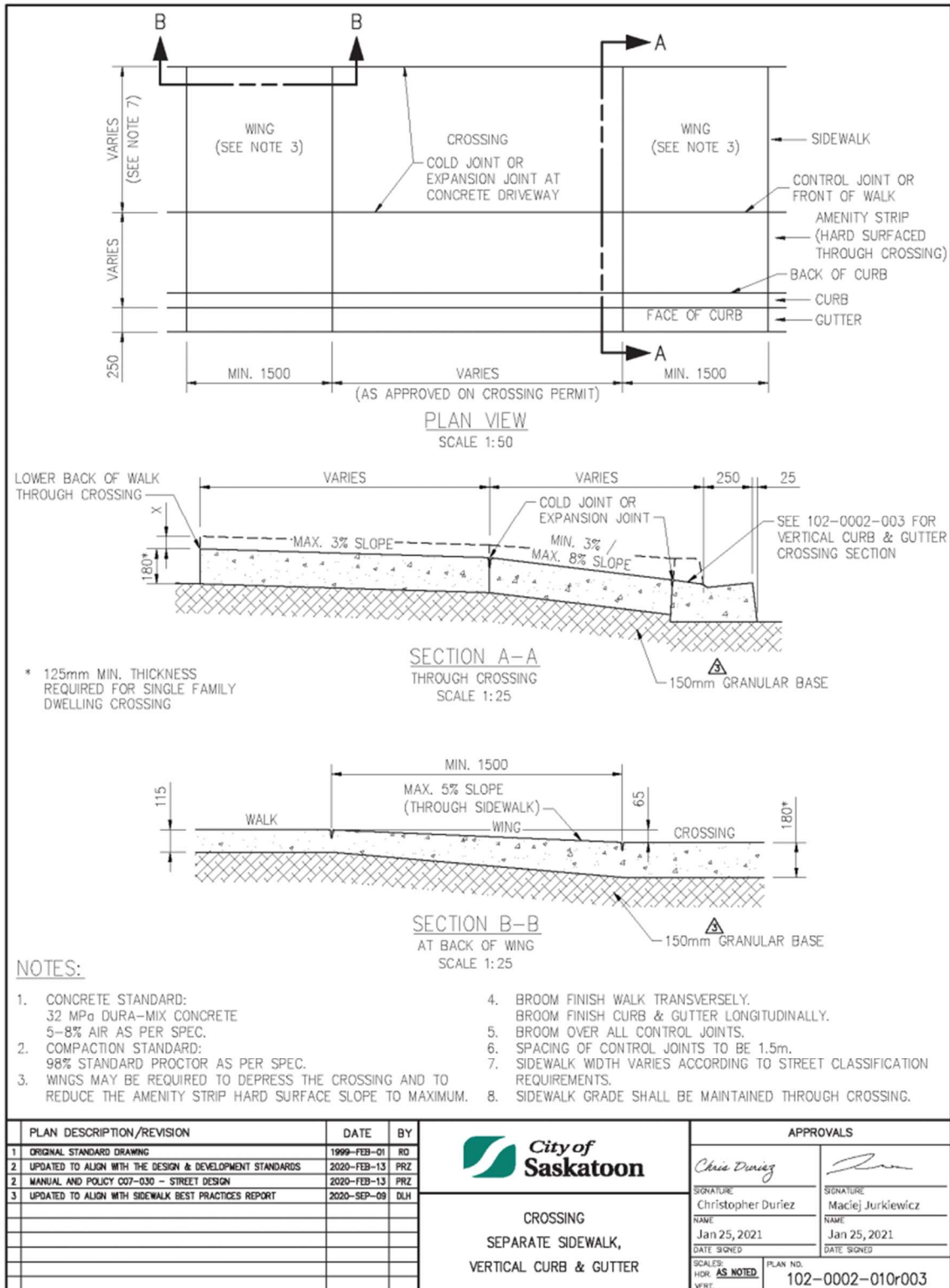

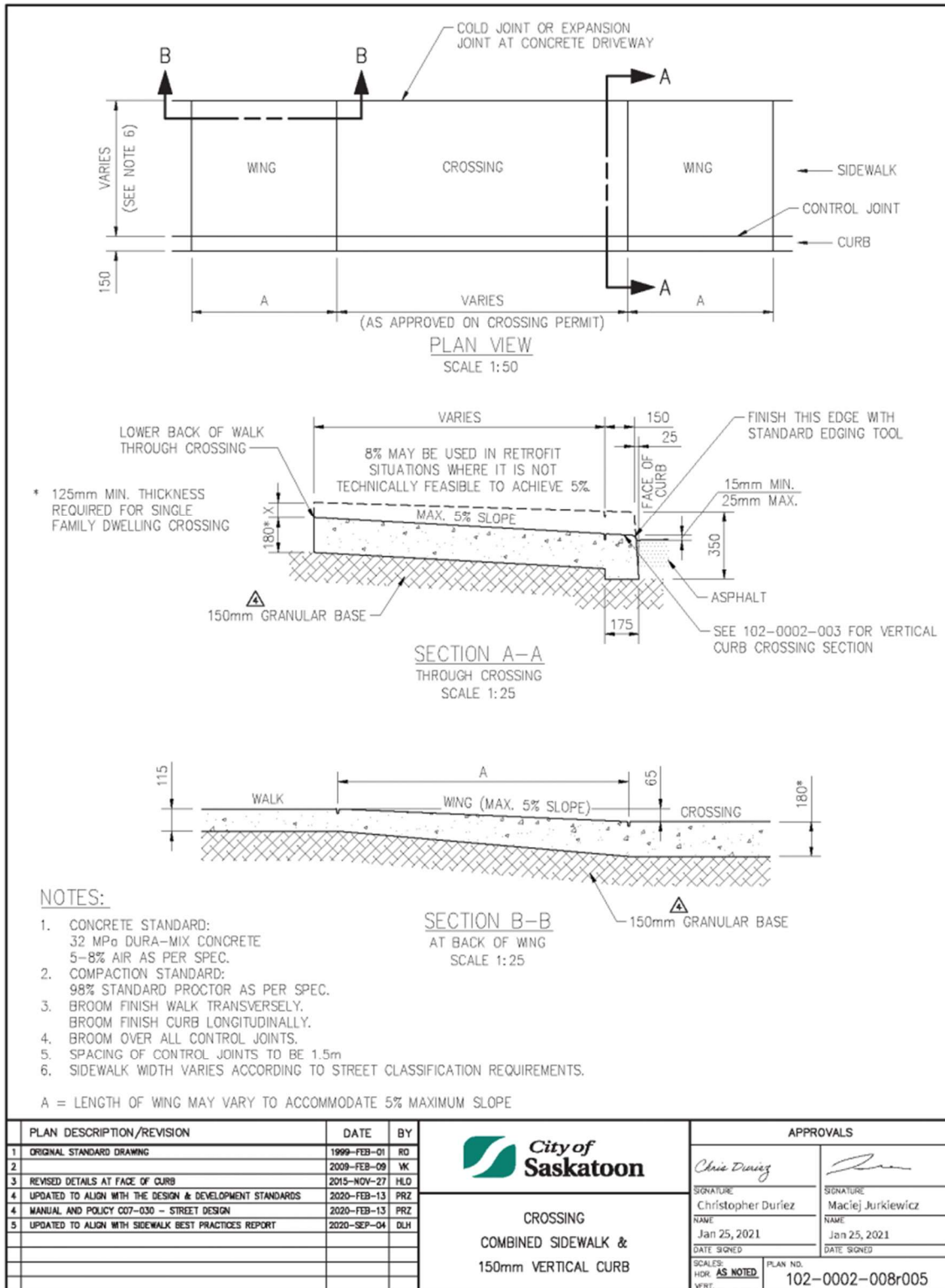

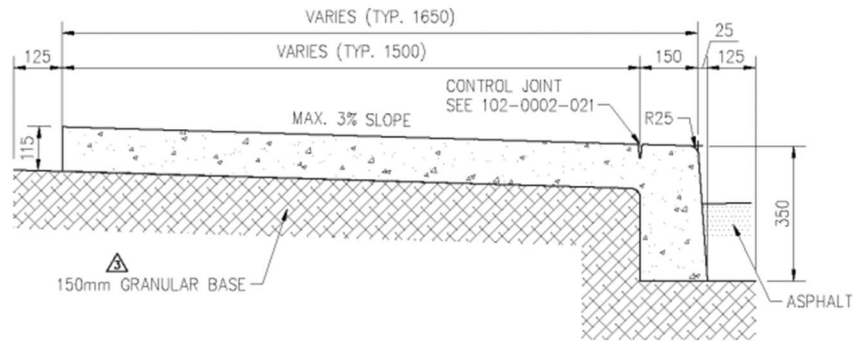

150mm VERTICAL CURB

NOTES:

1. CONCRETE STANDARD:
32 MPa DURA-MIX CONCRETE
5-8% AIR AS PER SPEC.
2. COMPACTION STANDARD:
98% STANDARD PROCTOR AS PER SPEC.
3. BROOM FINISH WALK, CURB FACE & GUTTER.
BROOM OVER ALL CONTROL JOINTS.
4. SPACING OF CONTROL JOINTS TO BE 1.5m.
5. VERIFY SIDEWALK WIDTH ACCORDING TO STREET CLASSIFICATION REQUIREMENTS. SIDEWALK WIDTH MAY VARY TO MATCH EXISTING FOR RETROFIT APPLICATIONS.

PLAN DESCRIPTION/REVISION	DATE	BY	APPROVALS											
1 ORIGINAL STANDARD DRAWING	1999-FEB-01	RD	 COMBINED SIDEWALK & VERTICAL CURB	<table border="1"> <tr> <td><i>Chris Duriez</i></td> <td><i>Maciej Jurkiewicz</i></td> </tr> <tr> <td>SIGNATURE: Christopher Duriez</td> <td>SIGNATURE: Maciej Jurkiewicz</td> </tr> <tr> <td>NAME: Jan 25, 2021</td> <td>NAME: Jan 25, 2021</td> </tr> <tr> <td>DATE SIGNED</td> <td>DATE SIGNED</td> </tr> <tr> <td>SCALE: HOR: 1:15 VERT:</td> <td>PLAN NO. 102-0002-033r003</td> </tr> </table>	<i>Chris Duriez</i>	<i>Maciej Jurkiewicz</i>	SIGNATURE: Christopher Duriez	SIGNATURE: Maciej Jurkiewicz	NAME: Jan 25, 2021	NAME: Jan 25, 2021	DATE SIGNED	DATE SIGNED	SCALE: HOR: 1:15 VERT:	PLAN NO. 102-0002-033r003
<i>Chris Duriez</i>	<i>Maciej Jurkiewicz</i>													
SIGNATURE: Christopher Duriez	SIGNATURE: Maciej Jurkiewicz													
NAME: Jan 25, 2021	NAME: Jan 25, 2021													
DATE SIGNED	DATE SIGNED													
SCALE: HOR: 1:15 VERT:	PLAN NO. 102-0002-033r003													
2 UPDATED TO ALIGN WITH THE DESIGN & DEVELOPMENT STANDARDS	2020-FEB-13	PRZ												
3 MANUAL AND POLICY C07-030 - STREET DESIGN	2020-FEB-13	PRZ												
3 UPDATED TO ALIGN WITH SIDEWALK BEST PRACTICES REPORT	2020-SEP-15	DLH												

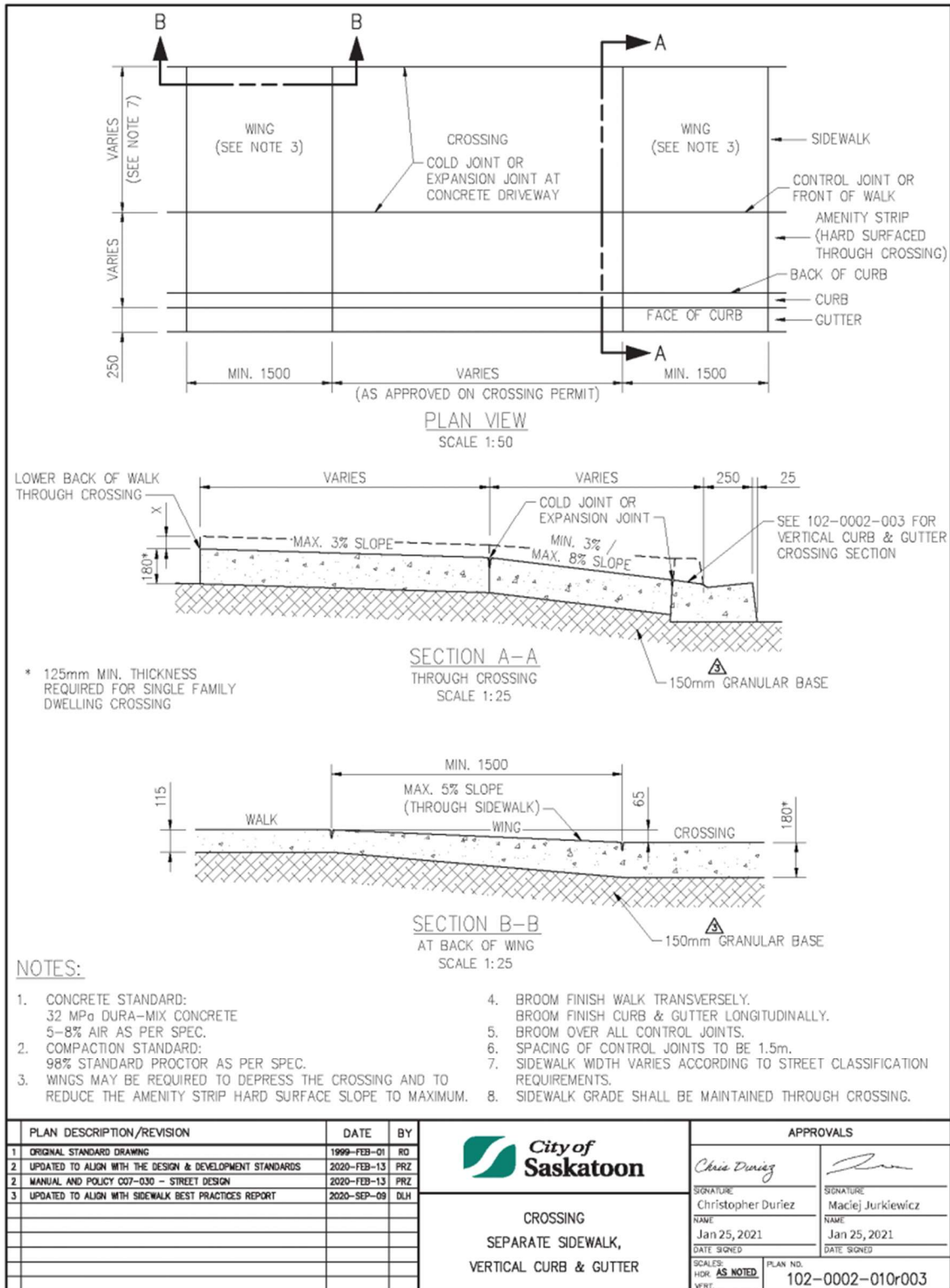

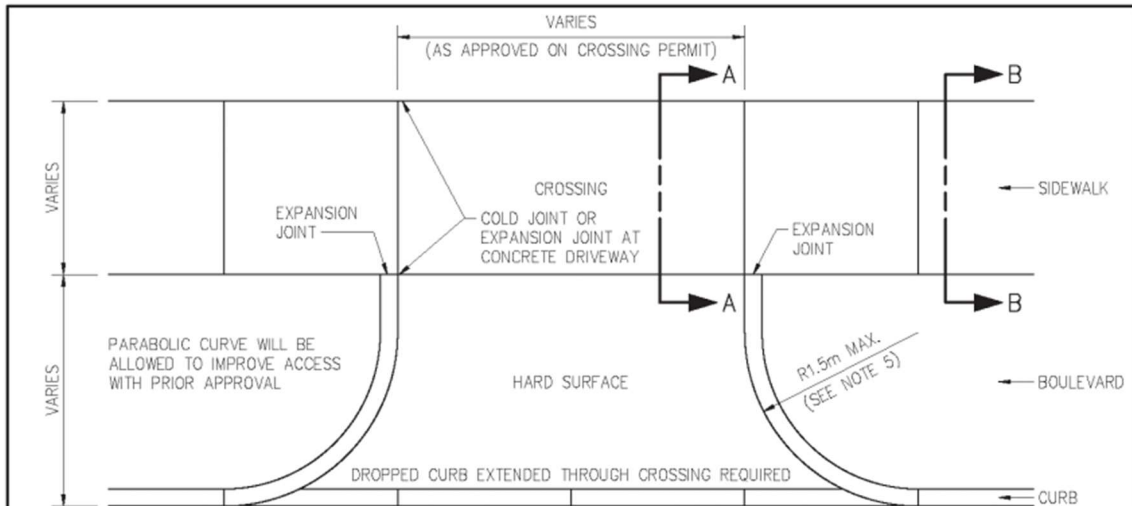

PLAN VIEW
SCALE 1:50

LOWER BACK OF WALK
THROUGH CROSSING

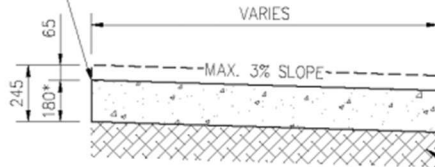

SECTION A-A
THROUGH CROSSING
SCALE 1:25

* 125mm MIN. THICKNESS
REQUIRED FOR SINGLE FAMILY
DWELLING CROSSING

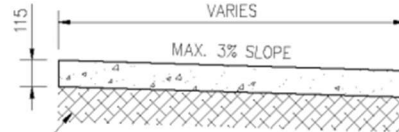

SECTION B-B
THROUGH SIDEWALK
SCALE 1:25

NOTES:

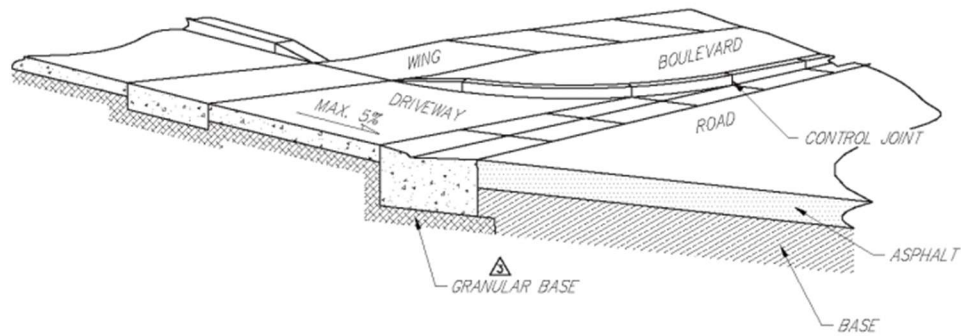

1. CONCRETE STANDARD:
32 MPa DURA-MIX CONCRETE
5-8% AIR AS PER SPEC.
2. COMPACTION STANDARD:
98% STANDARD PROCTOR AS PER SPEC.
3. BROOM FINISH WALK TRANSVERSELY. BROOM FINISH CURB & GUTTER LONGITUDINALLY.
4. BROOM OVER ALL CONTROL JOINTS.
5. TRUCK SWEEP PATH ANALYSIS OR TRAFFIC IMPACT STUDY REQUIRED FOR APPROVAL OF LARGER CORNER RADIUS.
6. SIDEWALK WIDTH VARIES ACCORDING TO STREET CLASSIFICATION REQUIREMENTS.
7. CONCRETE SIDEWALK TO CONTINUE THROUGH CROSSING AND GRADE SHALL BE MAINTAINED THROUGH CROSSING.
8. IF WINGS REQUIRED, MAX 5% SLOPE.

PLAN DESCRIPTION/REVISION	DATE	BY	APPROVALS	
1 ORIGINAL STANDARD DRAWING	1999-FEB-01	RD	 SIGNATURE Shirley Matt NAME Jan 25, 2021 DATE SIGNED	 SIGNATURE Maciej Jurkiewicz NAME Jan 25, 2021 DATE SIGNED
2 ADDED MAX RADIUS NOTE	2016-MAY-06	AMR		
3 UPDATED TO ALIGN WITH THE DESIGN & DEVELOPMENT STANDARDS	2020-FEB-13	PRZ		
4 UPDATED TO ALIGN WITH SIDEWALK BEST PRACTICES REPORT	2020-SEP-09	DLH		
 City of Saskatoon			CURB RETURN CROSSING SEPARATE SIDEWALK & VERTICAL CURB	
			SCALE: HOR: AS NOTED VERT:	PLAN NO. 102-0002-013r004



NOTES:

1. SIDEWALK GRADE AND SURFACE SHALL BE MAINTAINED THROUGH DRIVEWAY.
2. IF WINGS ARE REQUIRED, MAX 5% SLOPE.

PLAN DESCRIPTION/REVISION			DATE	BY	APPROVALS				
1	ORIGINAL STANDARD DRAWING		1999-FEB-01	RD	 CROSSING CURB DETAIL PERSPECTIVE VIEW	 SIGNATURE: Christopher Duriez NAME: Jan 25, 2021 DATE SIGNED		 SIGNATURE: Maciej Jurkiewicz NAME: Jan 25, 2021 DATE SIGNED	
2	UPDATED TO ALIGN WITH THE DESIGN & DEVELOPMENT STANDARDS		2020-FEB-13	PRZ		SCALE: HORIZ. <u>N.T.S.</u> VERT. _____ PLAN NO. 102-0002-017r003			
3	MANUAL AND POLICY C07-030 - STREET DESIGN		2020-FEB-13	PRZ					
	UPDATED TO ALIGN WITH SIDEWALK BEST PRACTICES REPORT		2020-SEP-09	DLH					

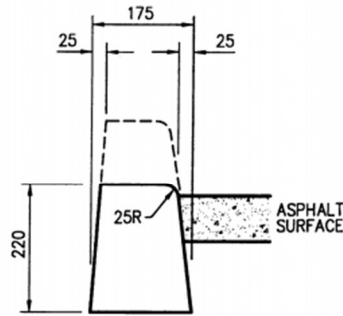

**150mm SEPARATE CURB
CROSSING SECTION**

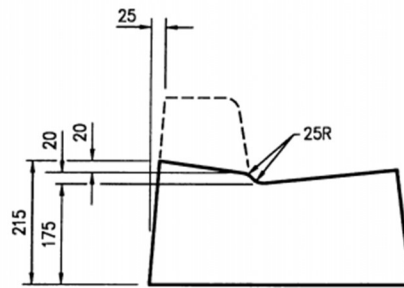

**VERTICAL CURB & GUTTER
CROSSING SECTION**

NOTES:

1. CONCRETE STANDARD:
32 MPa DURA-MIX CONCRETE
5-8% AIR AS PER SPEC.
2. COMPACTION STANDARD:
98% STANDARD PROCTOR AS PER SPEC.
3. STRAIGHT VERTICAL BACK OF CURB MAY
BE USED IN PLACE OF 25MM BATTER

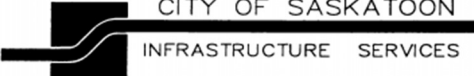
<table border="1" style="width: 100%; border-collapse: collapse;"> <thead> <tr> <th colspan="2" style="text-align: center;">REVISIONS</th> </tr> </thead> <tbody> <tr> <td style="width: 5%; text-align: center;">1</td> <td style="width: 95%;"></td> </tr> <tr> <td style="text-align: center;">2</td> <td></td> </tr> <tr> <td style="text-align: center;">3</td> <td></td> </tr> </tbody> </table>	REVISIONS		1		2		3		 <p>CITY OF SASKATOON INFRASTRUCTURE SERVICES</p>	<p style="text-align: center;">APPROVED</p> <p style="text-align: center;"><i>[Signature]</i> GENERAL MANAGER P. ENG.</p> <p>ENGINEER <i>[Signature]</i> ENGINEER</p> <p>SCALES : HOR. 1:10 VERT. _____</p>
REVISIONS										
1										
2										
3										
<p>DRAWN BY <u>R. OTTENBREIT</u> DATE <u>FEBRUARY 1, 1999</u></p> <p>CHECKED BY _____ DATE _____</p>	<p>SEPARATE DROPPED CURB CROSSINGS</p>	<p>C-3 PLAN NO. 102-0002-003r001</p>								

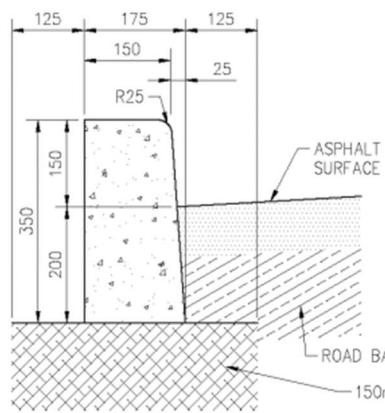

150mm CURB

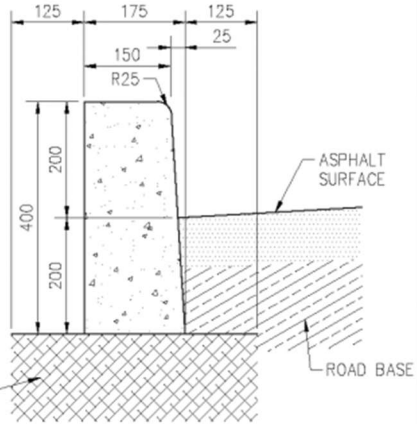

200mm CURB

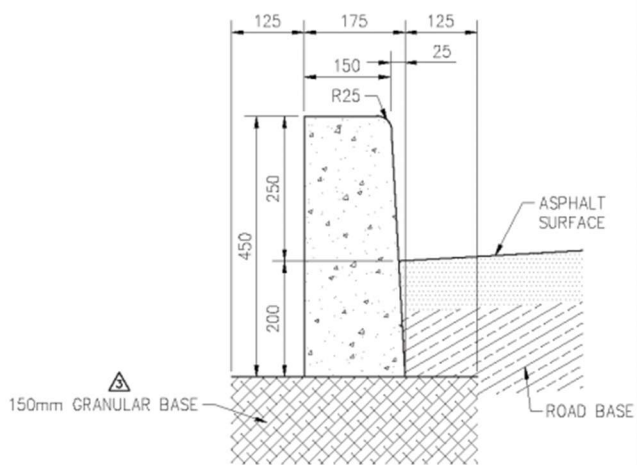

250mm CURB

APPROVED FOR USE AT TRANSIT STOPS

NOTES:

1. CONCRETE STANDARD:
32 MPa DURA-MIX CONCRETE
5-8% AIR AS PER SPEC.
2. COMPACTION STANDARD:
98% STANDARD PROCTOR AS PER SPEC.
3. BROOM FINISH TOP & FACE OF CURB AND GUTTER LONGITUDINALLY.
BROOM OVER ALL CONTROL JOINTS.
4. SPACING OF CONTROL JOINTS TO BE 1.5M

PLAN DESCRIPTION/REVISION	DATE	BY	APPROVALS	
1 ORIGINAL STANDARD DRAWING	1999-FEB-1	RD	 SIGNATURE: Christopher Duriez NAME: Jan 25, 2021 DATE SIGNED:	 SIGNATURE: Maciej Jurkiewicz NAME: Jan 25, 2021 DATE SIGNED:
2 ADDED 200mm & 250mm CURBS	2020-JAN-31	PRZ		
3 UPDATED TO ALIGN WITH SIDEWALK BEST PRACTICES REPORT	2020-OCT-08	DLH		
			SEPARATE VERTICAL CURBS	
			SCALE: HORIZ: 1:10 VERT: 1:10	PLAN NO. 102-0002-005r003

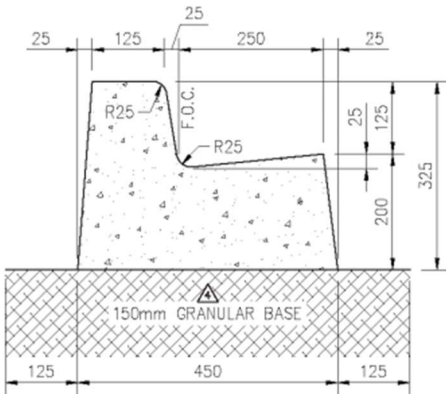

150mm VERTICAL C&G

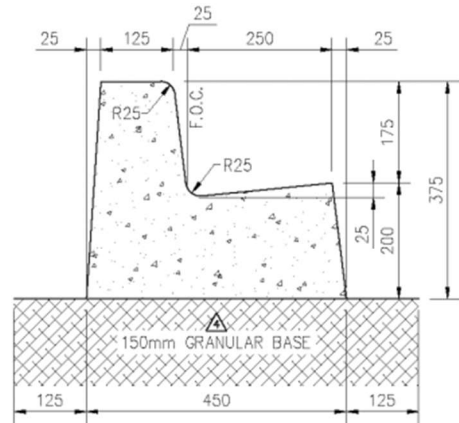

200mm VERTICAL C&G

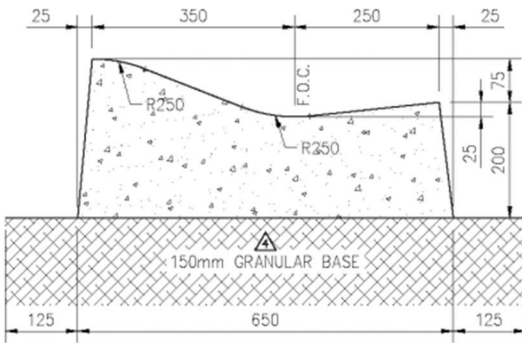

ROLLED CURB & GUTTER

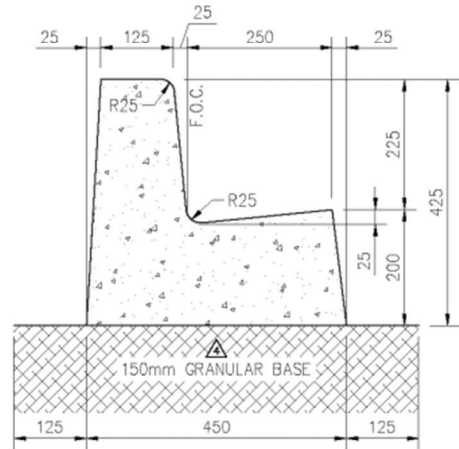



250mm VERTICAL C&G
APPROVED FOR USE AT TRANSIT STOPS

NOTES:

1. CONCRETE STANDARD:
32 MPa DURA-MIX CONCRETE
5-8% AIR AS PER SPEC.
2. COMPACTION STANDARD:
98% STANDARD PROCTOR AS PER SPEC.
3. BROOM FINISH TOP & FACE OF CURB AND GUTTER LONGITUDINALLY.
BROOM OVER ALL CONTROL JOINTS.
4. SPACING OF CONTROL JOINTS TO BE 1.5m

PLAN DESCRIPTION/REVISION	DATE	BY
1 ORIGINAL STANDARD DRAWING	1999-JUN-23	RD
2 REMOVED CONCRETE SWALE	2012-DEC-14	HLD
3 ADDED 250mm VERTICAL CURB & GUTTER	2020-JAN-31	PRZ
4 UPDATED TO ALIGN WITH SIDEWALK BEST PRACTICES REPORT	2020-SEP-08	DLH

City of Saskatoon
 FULL HEIGHT CURBS WITH GUTTER

APPROVALS	
 SIGNATURE Chris Duriez NAME Jan 25, 2021 DATE SIGNED	 SIGNATURE Maciej Jurkiewicz NAME Jan 25, 2021 DATE SIGNED
SCALES: HOR: 1:10 VERT: 1:10	PLAN NO. 102-0002-001r004

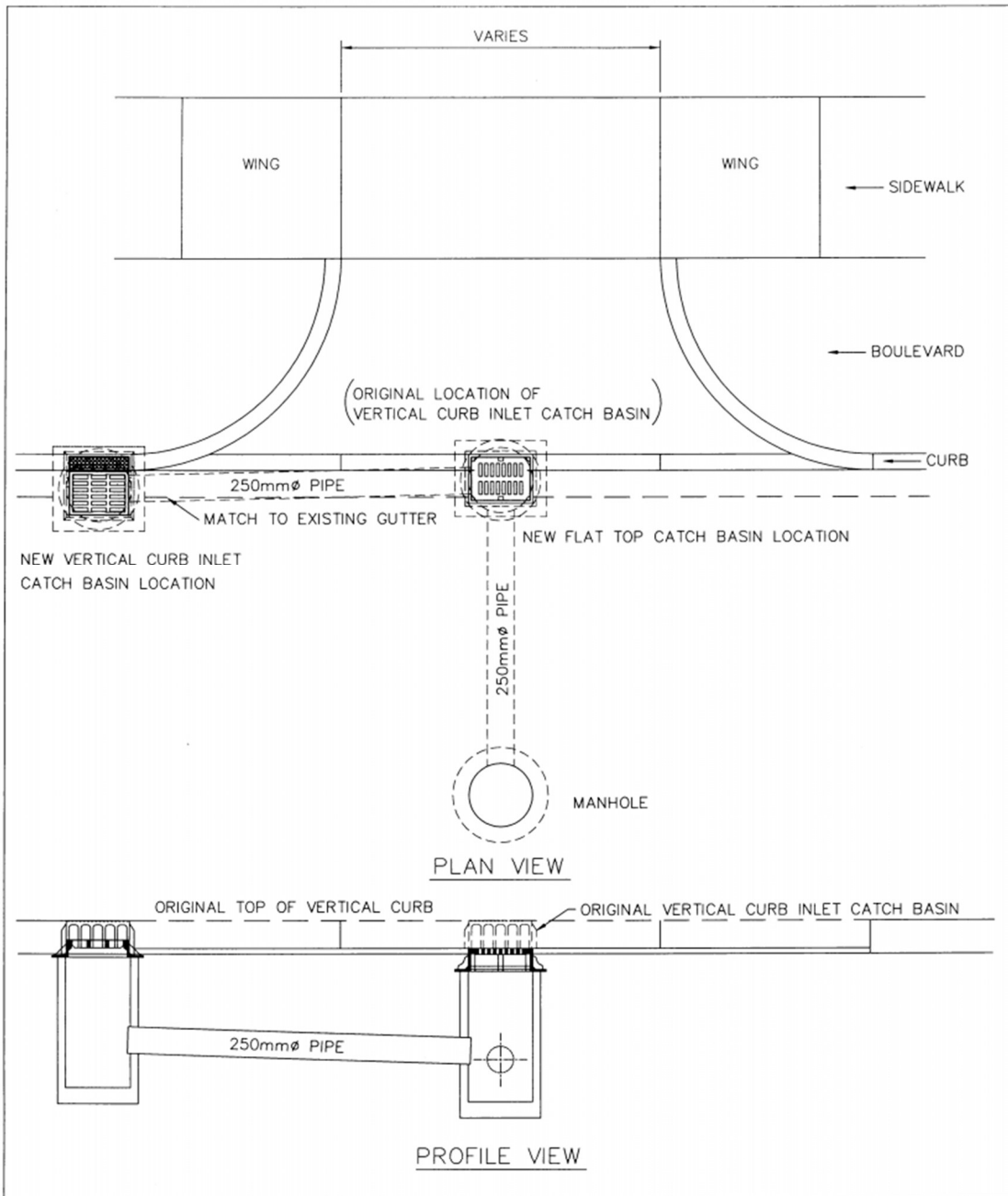

REVISIONS 1 _____ 2 _____ 3 _____			APPROVED GENERAL MANAGER P. ENG. ENGINEER ENGINEER	
DRAWN BY <u>RBV</u> DATE <u>NOVEMBER 16, 2004</u>			TYPICAL CATCH BASIN CONVERSION AT DRIVEWAY OR CROSSING	
CHECKED BY _____ DATE _____		SCALES : HOR. 1:50 PLAN NO. 102-0010-012r001		

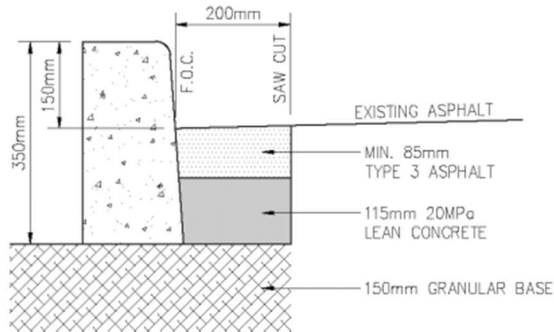

CURB

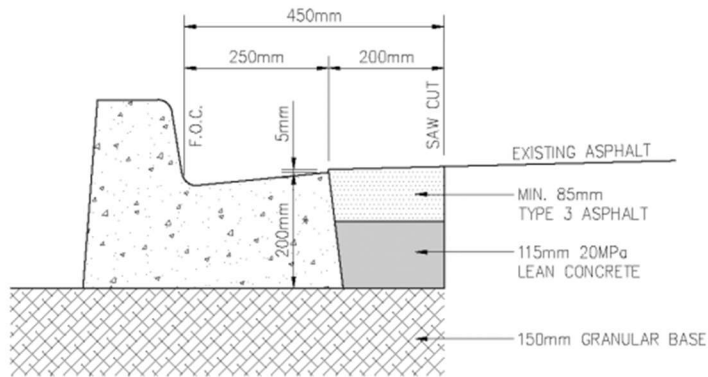

CURB & GUTTER

PLAN DESCRIPTION/REVISION	DATE	BY	City of Saskatoon		APPROVALS	
1 ORIGINAL DRAWING	2009-JAN-27	WK	GUTTER PATCH PAVING		 <small>FILED FEB 10 2021 12:20 CST</small> SIGNATURE Shirley Matt NAME Feb 10, 2021 DATE SIGNED	
2 ASPHALT DEPTH MIN. 85mm	2014-DEC-15	HLD			 SIGNATURE Maciej Jurkiewicz NAME Feb 10, 2021 DATE SIGNED	
3 UPDATED TO ALIGN WITH SIDEWALK BEST PRACTICES REPORT	2021-FEB-10	DLH			SCALE: HOR: 1:10 VERT:	
					PLAN NO. 102-0002-049-r003	

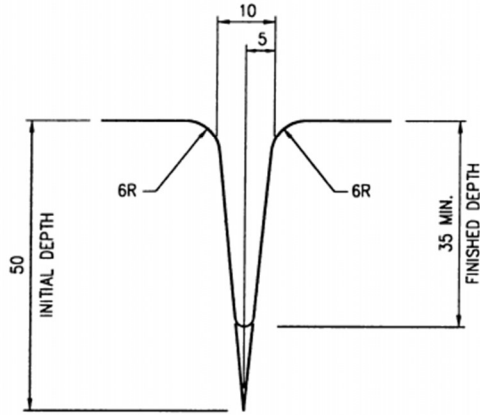

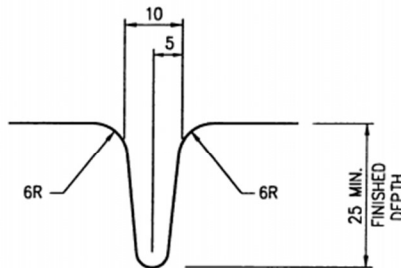

LONGITUDINAL CONTROL JOINT



TRANSVERSE CONTROL JOINT

TRANSVERSE CONTROL JOINTS MUST EXTEND ACROSS WALK & CURB, DOWN THE FACE OF CURB, AND ACROSS GUTTER

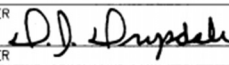
REVISIONS		 <p>CITY OF SASKATOON INFRASTRUCTURE SERVICES</p>	APPROVED	
1			 GENERAL MANAGER P. ENG.	
2			ENGINEER  ENGINEER	
3		CONTROL JOINTS	SCALES : HOR. 1:1 VERT. _____	
DRAWN BY <u>R. OTTENBREIT</u> DATE <u>FEBRUARY 1, 1999</u>			PLAN NO. 102-0002-021r001	
CHECKED BY _____ DATE _____				
			J-1	

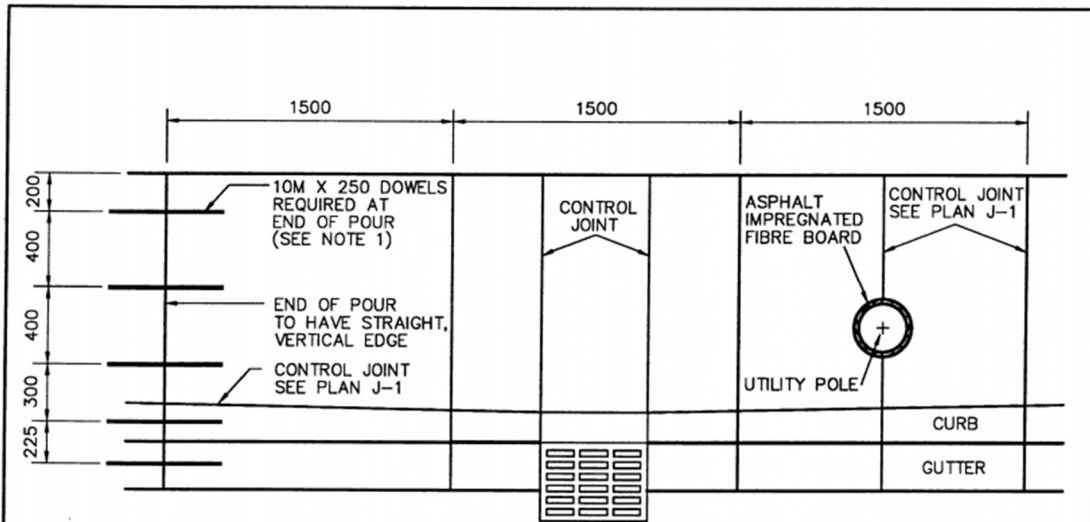

VERTICAL CURB

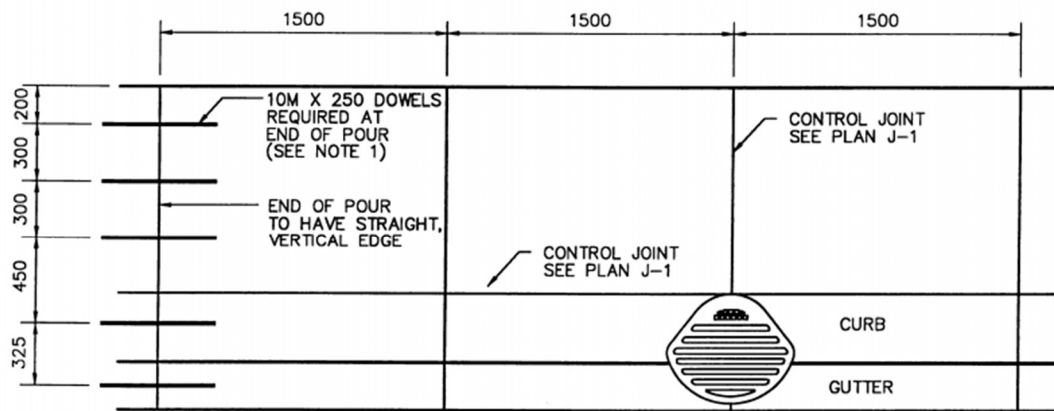

ROLLED CURB

NOTES:

- REBAR TO BE STAINLESS STEEL, EPOXY COATED, OR GALVANIZED. (EPOXY CAN NOT BE DRIVEN)

REVISIONS	
1	MOVED CURB CNTRL. JOINT
2	
3	

DRAWN BY R. OTTENBREIT
 DATE FEBRUARY 1, 1999

CHECKED BY _____
 DATE _____

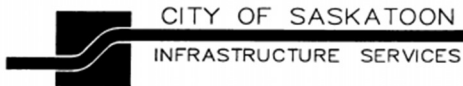

DOWEL/CONTROL JOINT LOCATION & SPACING

APPROVED

[Signature]
 GENERAL MANAGER P. ENG.

ENGINEER
[Signature]
 ENGINEER

SCALES : HOR. 1:30 VERT. _____

PLAN NO. **102-0002-022r001**

J-2

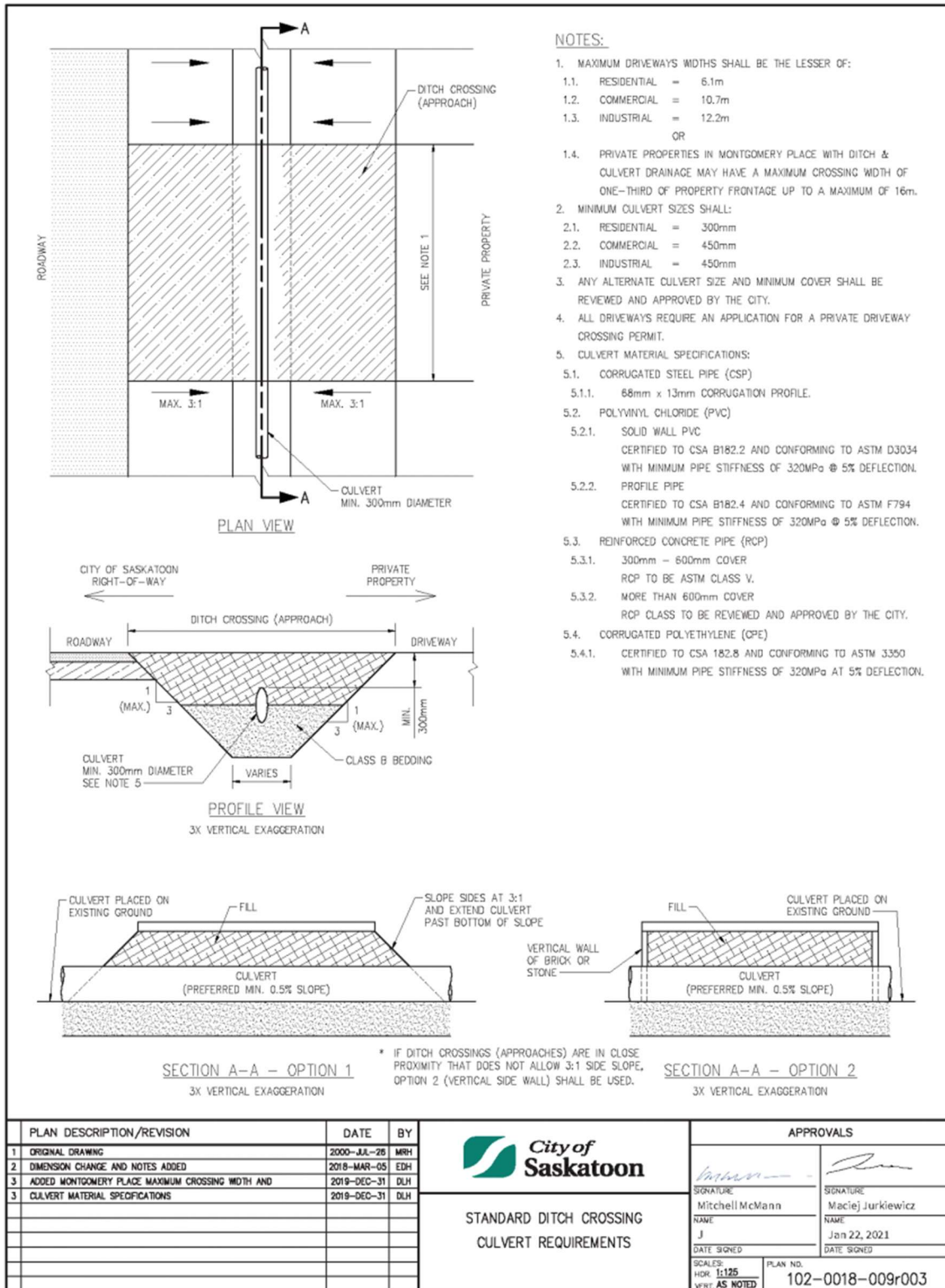

Contractors to be added to our Contractors List (2017)

The following list of contractors have expressed an interest in doing work for crossings and other work, and would like to be included on our list we hand out to homeowners and developers.

1. 14 – North – Mike – (306) 341-0723
2. Aberdeen Speciality Concrete – Ken – (306) 227-4491
3. Bellevue Construction Inc. – Gregg – (306) 221-6998
4. Bullfloat Concrete Ltd – Al – (306) 221-1113
5. Canadian Basement Replacements – Dave – (306) 270-0958
6. Capital Concrete Inc. – Alex – (306) 281-2370
7. City Gardens Ltd. – Luke – (306) 280-6609
8. Con-Tech General Contractors – Steve – (306) 250-1109
9. Conco – Mark – (306) 241-6200
10. Concrete Work – Vasyl Myrutenko – (306) 850-1872
11. Contour Developments – Karl – (306) 290-6353
12. Dunmac General Contractors – Ryan – (306) 260-6078
13. Friesen Concrete Ltd. – Rob – (306) 229-4280
14. Highmark Foundations – Dan – (306) 220-9703
15. JMF Concrete Construction – Murry – (306) 261-2346
16. Key Concrete Services – John – (306) 716-8993
17. Lafarge – John Jones – (306) 221-3934
18. Little Pine Concrete – Gary – (306) 241-8933
19. Local Asphalt Ltd. (City Concrete Ltd) – Jeton – (306) 221-7918
20. Mid-West Damproofing – Brad – (306) 261-0894
21. MN Construction – Mark – (306) 361-3910
22. Mustang Concrete – Phil – (306) 880-5857
23. Newwestern – Kyle – (306) 716-1315
24. Next Level Concrete Services – Marshall – (306) 881-3732
25. Nienhuis Contractors Ltd. – Jordan – (306) 250-3308
26. Prairie Life Construction – Marshall – (306) 241-0694
27. Procrete Concrete Services – Kevin Balzer – (306) 290-6656
28. Quorex Construction – Rick – (306) 222-9977
29. Richter Masonary – Peter – (306) 384-3301
30. Rockwell Concrete – Jared – (639) 317-9506
31. Saskatoon Concrete Developments – Tyler – (306) 716-7687
32. Scenic Land & Construction – Angelo – (306) 717-0262
33. WB Construction – Wilf – (306) 280-9681
34. Wilco – Liam – (306) 361-4855
35. Virtue Construction Ltd. – Billy – (306) 251-0177



Protect Saskatoon Trees

URBAN FORESTRY

Tree Protection Required When Working Near City Trees

Equipment and vehicles can injure tree trunks, break branches, tear bark, cause soil compaction or damage roots.

If you are planning any work near a City tree you are responsible for providing tree protection measures as determined

by the Urban Forestry Section of the Parks Branch.

Any unauthorized excavation, removal, relocation, pruning, or damage of City trees may result in a fine or penalty as per City Council Policy #C09-011.

Damage to City trees will be assessed on the value of the plant material as well as the cost of any removal or repairs.

Plan Ahead - Contact Urban Forestry at **306-986-0836** before you proceed with any construction near City trees.

When working near City trees the required protective measures include the following:

Protect the tree roots

Severing tree roots, compacting soil, or changing the grade in the critical root zone of a tree can impact both the health and stability of a tree.

- You will only be permitted to excavate on one side of a tree.
- If construction takes place when soil moisture levels are high, it increases compaction within the drip zone.
- All exposed roots must be pruned with a sharp pruning tool to provide a clean severance of the root.
- Exposed roots must be protected from drying during construction and exposed roots must be backfilled as soon as possible.
- To prevent compaction 150mm (6") of woodchip mulch must be placed on any area under the drip line of a protected tree if it is not fenced off.

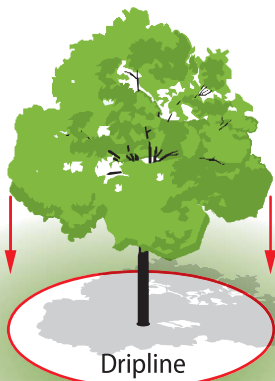

Provide Protective Fencing

The best way to avoid tree damage at construction sites is to set up a protective fence to act as a physical barrier to keep vehicles, equipment, and materials away from trees.

Protective fencing must be constructed of either:

- a) Solid wood frame with orange snow fencing securely stapled to the outside;
- or
- b) Snow fencing fastened securely to metal stakes spaced no more than 1 meter apart.

Protective fencing must:

- Be 1.2 meters high measured from the ground;
- Not interfere with access to fire hydrants or obscure intersections or traffic signage;
- Be sturdy with vertical posts driven firmly into the ground to keep it in place;
- Stay in good repair for the duration of the demolition or construction project.

For safety reasons an underground utility check must be completed before installing the fence to ensure you do not hit any buried utilities.

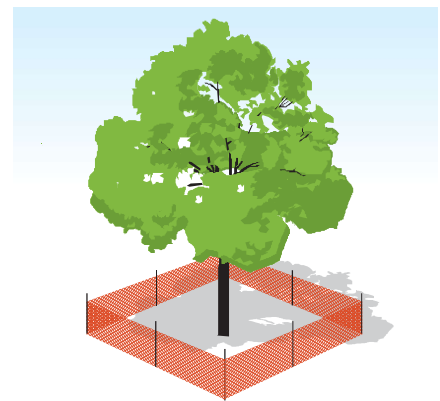

Protective Fencing

Construction of the protective fencing will be inspected and must be acceptable to Urban Forestry.

Tree Protection Zone Radius Requirements

(measured from base of tree)

Trunk Diameter @ 1.2m	Good Protection	Better Protection
1 – 20 cm	2.0 m	3.0 m
21 – 50 cm	2.5 m	4.5 m
50+ cm	3.5 m	6.5 m



City of
Saskatoon

<http://www.saskatoon.ca/go/forestry>

PRIVATE DRIVEWAY CROSSING GUIDELINES

The following guidelines are for the installation of driveway crossings. These guidelines are to be applied in conjunction with Bylaw 4785 (The Private Crossing Bylaw), and constructed to the Construction & Design Division's specifications.

GUIDELINES

- 1) Driveway crossings require an Application and Permit. The Application is usually a part of the Building Permit on commercial and industrial properties and shall include a site plan containing information outlined in item 2). Once the driveway crossing has been approved, a Crossing Permit may be obtained from the Transportation & Utilities Division (306-986-9727).
- 2) A site plan is required with the following information:
 - a) Property lines and adjacent street curbs drawn to scale
 - b) Desired width of each crossing
 - c) Location of the crossing with relation to property lines and intersections (if on a corner lot)
 - d) Location of all City trees on the boulevard
 - e) Zoning designation of the parcel
- 3) In conjunction with the Crossing Permit, two inspections will be undertaken by City of Saskatoon, Construction & Design Inspectors. The first inspection will take place when the base and forms are in place. The second inspection will take place after the crossing has been finished. The inspections are to ensure that all driveway crossings are constructed to the most current City of Saskatoon Standards and Specifications. Arrangement for inspections can be made by the Transportation & Utilities clerical staff once a permit has been issued (306-986-9727).
- 4) The maximum width for driveway crossings is as follows:
 - a) Residential: 6.1 metres (20')
 - b) Commercial: 10.7 metres (35')
 - c) Industrial: 12.2 metres (40')
- 5) Driveways shall not be constructed which are more than one third of the total property frontage or flankage.
- 6) For signalized intersections, the following minimum corner clearances shall be observed:
 - a) Arterials – 70 metres (230')
 - b) Collectors – 55 metres (180')
 - c) Local – 15 metres (50')

- 7) For un-signalized intersections, the following minimum corner clearances shall be observed:
 - a) Arterials – 30 metres (100')
 - b) Collectors – 20 metres (66')
 - c) Local – 15 metres (50')
- 8) The minimum distance between two driveway crossings is 3 metres.
- 9) Driveway crossings shall be constructed at least 1 metre (residential) and 3 metres (commercial and industrial) away from a property line in order to accommodate curb returns.
- 10) If a driveway crossing is requested on a roadway classified as an arterial or higher, a Traffic Impact Study may be required. High density or intense commercial developments may also require a Traffic Impact Study.
- 11) Driveway crossings which include a request for a median opening require Council approval pursuant to Policy C07-012
- 12) Shared driveway crossings between two property lines are not encouraged, but may be permitted as long as a shared driveway agreement is in place between the owners of both properties. A copy of this agreement will be required prior to the approval of any shared driveway crossing application.
- 13) Properties with lane access are encouraged to have their primary access off of the lane
- 14) Multi-unit developments with the majority of their parking accessing the alley/lane are required to pave the lane from the parking area to the nearest street.
- 15) Driveway crossings must be at least 3.0 metres from any existing tree on City owned land. It is recommended that interested parties contact the Urban Forestry section of the Parks Division of the Community Standards department for more information.
- 16) No City owned tree may be removed to accommodate installation of a private driveway crossing.

Bylaw No. 4785

The Private Crossings Bylaw, 1968

**Codified to Bylaw No. 9648
(September 30, 2019)**

BYLAW NO. 4785

A bylaw to regulate the installation of private crossings in the City of Saskatoon.

The Council of The City of Saskatoon enacts as follows:

1. Any owner who desires to construct a private crossing over a concrete or asphalt sidewalk, curb or boulevard for the purpose of gaining vehicular access to the owner's property, shall, individually or through an authorized agent, submit a written application to the General Manager of Transportation & Construction for a permit.
2.
 - (1) Every such application shall describe in detail the premises to which such access is desired, and shall be accompanied by a plan of the proposed crossing showing all trees, light standards, hydrants, catch basins and other civic property or works which might be affected by its installation, and shall contain such additional data as the General Manager of Transportation & Construction may require.
 - (2) The owner shall, in the application, undertake to remove the said crossing whenever required by Council to so do, and restore the sidewalk to its original conditions, or to pay the City the cost of such removal and restoration.
3. "Owner" in this bylaw shall mean either the assessed owner or the registered owner.
4.
 - (1) The General Manager of Transportation & Construction, after approving the application of the owner, may issue a permit for the construction of curb or sidewalk crossings in accordance with the following schedule:
 - (a) INTERIOR RESIDENTIAL SITE - two (2) crossings with a maximum combined total width of not more than twenty (20) feet.
 - (b) CORNER RESIDENTIAL SITE - one (1) crossing on frontage and one (1) on flankage either of which shall not be greater in width than sixteen (16) feet; or two (2) crossings either on frontage or flankage with a total combined width of not more than twenty (20) feet.
 - (c) INTERIOR COMMERCIAL SITE UP TO ONE HUNDRED (100) FEET IN FRONTAGE - One (1) twenty-five (25) foot crossing or two (2) sixteen (16) foot crossings.

- (d) INTERIOR COMMERCIAL SITE WITH FRONTAGE OR MORE THAN ONE HUNDRED (100) FEET BUT NOT MORE THAN TWO HUNDRED (200) FEET - one (1) twenty-five (25) foot crossing and one (1) thirty-five (35) foot crossing.
 - (e) CORNER COMMERCIAL SITE - two (2) crossings on the major side and one (1) crossing on the minor side wherein one of the three crossings may be up to twenty-five (25) feet wide, and the remaining two each up to twenty (20) feet wide.
 - (f) INTERIOR INDUSTRIAL SITE WITH FRONTAGE NOT EXCEEDING ONE HUNDRED AND FIFTY (150) FEET - one (1) thirty (30) foot crossing or two (2) twenty (20) foot crossings.
 - (g) INTERIOR INDUSTRIAL SITE WITH FRONTAGE GREATER THAN ONE HUNDRED AND FIFTY (150) FEET - the number of crossings may be authorized by the General Manager of Transportation & Construction according to the area and frequency of usage of property concerned, provided however that no one crossing shall have a width of greater than forty (40) feet.
 - (h) CORNER INDUSTRIAL SITE - subsections (f) and (g) apply to both frontage and/or flankage dimensions.
- (2) Notwithstanding Subsections (b), (e) and (h), no corner lot crossing shall be permissible with its outer limit a distance of less than twenty (20) feet from the intersection of the property lines except on directional crossings, in which case the inbound crossing may commence with its outer limit fifteen (15) feet from the intersection of the property lines.
 - (3) Subsection (2) does not apply to property zoned Residence R.1, R.2 and R.3 Districts under the Zoning Bylaw.
 - (4) Corner crossings on property zoned Residence R.1, R.2 and R.3 may commence at the tangent point of the curb return, and one of the crossing wings may be in the curb return.
 - (5) Applications for crossings of a greater number of a width greater than permitted by this bylaw shall be referred by the General Manager of Transportation & Construction to the City Manager for presentation to Council, such application to be accompanied with a report from the General Manager of Transportation & Construction.

- (6) In this section the following expressions shall mean as follows:
- (a) INTERIOR SITE - a site which has street right-of-way on one side only.
 - (b) CORNER SITE - a site which has street right-of-way on two or more sides.
 - (c) COMMERCIAL SITE - is any piece of land in a B or M District.
 - (d) INDUSTRIAL SITE - is any piece of land that is in an I.D District.
 - (e) RESIDENTIAL LOT - is any piece of land in an R District.
5. In cases where the crossing is to be installed by the City, the applicant shall, prior to the commencement of the work, deposit with the City Treasurer the estimated cost thereof. Should the amount deposited prove to be less than the actual cost of the work, the owner shall pay the City the balance forthwith upon the completion of the work. If the amount deposited proves to be more than the actual cost, the excess shall be repaid to the applicant by the City Treasurer.
6. Every such crossing shall be constructed in accordance with current standard plans, specifications and profiles for standard or directional crossings on file in the office of the General Manager of Transportation & Construction.
7. Every such crossing shall when installed, be kept clean and in a good and proper state of repair, and clear of ice and snow, by the owner of the premises to which access is afforded thereby, and the General Manager of Transportation & Construction may from time to time carry out at the expense of such owner any repairs to or cleansing of the crossing that the General Manager deems necessary. In default of the owner paying to the City in advance the estimated cost of carrying out such repairs or cleansing, the City may remove the crossing forthwith and cut off access to the property thereby.
8. Bylaws No. 1881, No. 2377, No. 2502 and No. 3941 are hereby repealed.
9. This bylaw shall come into force and take effect on the day of the final passing thereof.

Read a first time this 11th day of March A.D. 1968.
Read a second time this 11th day of March A.D. 1968.
Read a third time and passed this 11th day of March A.D. 1968.

"J.B. Wedge"
Deputy Mayor

"L.A. Kreutzweiser"
City Clerk

(SEAL)