

REPORT

Imagine Idylwyld



Transportation and Connectivity Final Technical Report

May 2018

CONFIDENTIALITY AND © COPYRIGHT

This document is for the sole use of the addressee and Associated Engineering (Sask.) Ltd. The document contains proprietary and confidential information that shall not be reproduced in any manner or disclosed to or discussed with any other parties without the express written permission of Associated Engineering (Sask.) Ltd. Information in this document is to be considered the intellectual property of Associated Engineering (Sask.) Ltd. in accordance with Canadian copyright law.

This report was prepared by Associated Engineering (Sask.) Ltd. for the account of HOK, Inc. The material in it reflects Associated Engineering (Sask.) Ltd.'s best judgement, in the light of the information available to it, at the time of preparation. Any use which a third party makes of this report, or any reliance on or decisions to be made based on it, are the responsibility of such third parties. Associated Engineering (Sask.) Ltd. accepts no responsibility for damages, if any, suffered by any third party as a result of decisions made or actions based on this report.

Table of Contents

SECTION	PAGE NO.
Table of Contents	i
List of Tables	iii
1 Background	1
1.1 Summary of Previous Phases and Reports	1
1.2 Engineering Standards of Care	1
1.3 Technical Reference Publications	2
2 Corridor Design Concepts	3
2.1 Basic Design Concept	3
2.2 Lane Alignment and Continuity	3
2.3 Lane Widths	4
2.4 Curb Radius and Channelization	4
2.5 Design Vehicle	4
2.6 Sidewalks	5
2.7 Medians	7
2.8 Bicycle Crossings	7
2.9 Safety Performance	8
3 Intersection Area Design Concepts	9
3.1 20th Street / Avenue A Intersection Area	9
3.2 Auditorium Avenue Intersection Area	9
3.3 21st Street West Intersection Area	10
3.4 22nd Street Intersection Area	10
3.5 23rd Street West Intersection Area	11
3.6 23rd Street East / Jamieson Street Intersection Area	11
3.7 24th Street East Intersection Area	12
3.8 25th Street Intersection Area	12
4 Mobility	13
4.1 Conditions for Drivers	13
4.2 Conditions for People Walking	19
4.3 Conditions for People Riding Bicycles	22
4.4 Conditions for People Using Transit	22

4.5	Conditions for Freight Trucks	23
5	Summary of Recommendations	24
5.1	Recommended Functional Design	24
5.2	Future Study	25

References

Certification Page

Appendix A – Functional Corridor Plans

Appendix B – Current Conditions and Improvement Options Report, March 2017

Appendix C – HCM 2010 Analysis: Current Configuration

Appendix D – HCM 2010 Analysis: Recommended Configuration

Appendix E – Microsimulation Analysis

List of Tables

	PAGE NO.
Table 2-1 Lane Widths	4
Table 2-2 Sidewalk Design Parameters	6
Table 4-1 Signal Cycle Time	13
Table 4-2 Level of Service Comparison, AM Peak	14
Table 4-3 Level of Service Comparison, PM Peak	15
Table 4-4 Average Delay Comparison, AM Peak	15
Table 4-5 Average Delay Comparison, PM Peak	16
Table 4-6 Volume to Capacity Ratio Comparison, AM Peak	16
Table 4-7 Volume to Capacity Ratio Comparison, PM Peak	17
Table 4-8 Simulated Corridor Travel Times, PM Peak	18
Table 4-9 Observed Travel Times, PM Peak	18
Table 4-10 Maximum Pedestrian Wait	19
Table 4-11 Crosswalk Length Comparison	20
Table 4-12 Pedestrian Clearance Interval	21
Table 4-13 Time Accommodated to Clear 20 m Crosswalk	22

1 Background

1.1 SUMMARY OF PREVIOUS PHASES AND REPORTS

This report is intended as the final technical report for the Imagine Idylwyld conceptual corridor planning study. It accompanies the Recommended Functional Plan drawings, included as Appendix A.

However, this report is not intended to cover all aspects of the study process. Numerous previous reports have been submitted. The final submission for this project includes all previous reports.

- Phase 2 Transportation and Connectivity, Current Conditions and Improvement Options (AE, March 2017)
- Phase 2 Issues and Opportunities Report (HOK with AE, April 2017)
- Phase 3 Corridor Alternatives Report (HOK with AE, November 2017)
- Phase 4 Concept Design Report (HOK with AE, April 2018)

The Phase 2 Transportation and Connectivity, Current Conditions and Improvement Options Report has been included as Appendix B to this report.

1.2 ENGINEERING STANDARDS OF CARE

The following standards of care were established at the outset of the project:

- All modes of travel must be considered and accommodated. This includes Walking, Cycling, Driving, Transit, and Freight.
- All types of people must be considered and accommodated. This includes children, able-bodied adults, seniors, wheelchair users, the visually impaired, and the hearing impaired.
- Idylwyld Drive will be designed as an urban street. Grade separations (overpasses and underpasses) will not be considered. The street will be designed to be safe and to encourage driving speeds around the speed limit of 50 km/h.
- Idylwyld Drive will remain an arterial street. It will be designed for the safe and efficient movement of large volumes of cars and trucks as a key link in the city's motor vehicle transportation network.
- Land use and transportation planning are integrated. The street design will be compatible with the intended land use, not the other way around. The intended land use will be determined through this study process.
- Existing businesses and driveways will be accommodated. There is no intent to force anyone out, but over the long term the access to adjacent properties may evolve along with the land use.
- Saskatoon is a winter city. Winter weather and snow management will be considered in the street design.
- The most up-to-date engineering design standards, guidelines, and best practices will be used. Modern guidelines allow a great deal of context-sensitive approaches. Idylwyld Drive is not a suitable context for pioneering street design elements never before used or researched for use in Canada.

1.3 TECHNICAL REFERENCE PUBLICATIONS

Many technical publications will be used as references to guide the selection of design parameters. In general, publications from the Transportation Association of Canada (TAC), the Institute of Transportation Engineers (ITE), the Transportation Research Board (TRB), and the National Association of City Transportation Officials (NACTO) were used for reference. The City of Saskatoon *New Neighbourhood & Development Standards Manual* (DSM) was not generally used for reference as it is not intended for the context of retrofitting existing streets in a city centre environment. Reference material more than ten years old was considered less relevant than more current publications, as there have been significant advances in engineering best practices for multi-modal urban street design in that time.

Of particular note, an update to the *Geometric Design Guide for Canadian Roads* (GDG) was published in 2017, superseding the version used since 1999. The new edition contained noteworthy changes to arterial street design guidance, notably lane width, as well as expanded design guidance for bicycle facilities.

The following publications were used for the project:

- Geometric Design Guide for Canadian Roads (TAC, 2017)
- Geometric Design Guide for Canadian Roads (TAC, 1999)
- Designing Walkable Urban Thoroughfares: A Context Sensitive Approach (ITE, 2010)
- Urban Street Design Guide (NACTO, 2013)
- Canadian Capacity Guide for Signalized Intersections, 3rd Edition (TAC and ITE, 2008)
- Highway Capacity Manual (TRB, 2010)
- Bikeway Traffic Control Guidelines for Canada, 2nd Edition (TAC, 2012)
- Pedestrian Crossing Control Guide (TAC, 2012)

2 Corridor Design Concepts

2.1 BASIC DESIGN CONCEPT

As a general summary, the basic design features:

- Four basic continuous lanes through the study area.
- Auxiliary dedicated left turn lanes anywhere left turns are permitted on Idylwyld Drive.
- Head to head opposing left turn lanes where applicable.
- Driving lanes either 3.0 m or 3.3 m in width.
- Bicycle paths a minimum of 1.5 m wide, located at sidewalk elevation.
- Sidewalks a minimum of 1.8 m wide.
- A tactile separation 0.3 m wide between the designated bicycle and pedestrian portions of the sidewalk.
- Landscaping strips of variable width and type between the driving lanes and the bicycle paths.
- Consistent pedestrian walk time based on a maximum 1.2 m/s assumed walking speed.
- Concrete medians at the ends of the study corridor to assist with the transition from the cross section to the north and south.
- Southbound right turn auxiliary lanes at the 22nd Street and 20th Street intersections.
- Re-designation of the northbound shared left/through lane at the 22nd Street intersection to be for through traffic only, to enable permissive left turns and improved signal coordination along the corridor.
- Doubling the length of the remaining single left turn bay for northbound traffic turning west at the 22nd Street intersection.
- Establishment of a formalized connection across Idylwyld Drive between the Blairmore Bikeway and the 23rd Street East protected bike lanes.
- Prohibition of northbound left turns from Idylwyld Drive to the private driveway at the 24th Street East intersection, because there was not sufficient space for a dedicated left turn lane.

2.2 LANE ALIGNMENT AND CONTINUITY

The GDG defines the basic number of lanes as “a minimum number of lanes designated and maintained over a significant length of route” (p. 3-91). Idylwyld Drive has four basic lanes through the rest of Saskatoon both north and south of the study area. The recommended basic number of lanes through the study area is therefore also four, to which auxiliary lanes are added for individual locations.

TAC also states that operational problems on higher-classification roadways are attributable to “failure to maintain route continuity” (p. 3-95) This is currently observed in the southbound direction, where the two lanes entering the study area are not continuous with the two lanes departing the study area, forcing many drivers to make a lane change to continue on the same route. The recommended plan improves continuity by having the two lanes approaching the study area from the north be continuous with the two lanes departing the study area toward the south, and vice-versa.

2.3 LANE WIDTHS

Lane widths were selected in Phase 2 as described in Appendix B. Typical lane widths for Idylwyld Drive are summarized in Table 2-1. Exceptions to the typical lane widths occur at the transitions to the study area, to tie in to existing infrastructure.

**Table 2-1
Lane Widths**

Parameter	Width
Curb Lane	3.3 m
Inner Lane	3.0 m
Left Turn Lane	3.0 m
Gutter	0.25 m

2.4 CURB RADIUS AND CHANNELIZATION

The minimum radius proposed in Phase 2 was 7.5 m or the design vehicle. In most cases, the design vehicle governs. Curb radii for each intersection are illustrated in the recommended plans shown in Appendix A.

The recommended plan has eliminated channelized right turns except at 25th Street East, where the railway crossing constrains opportunities for design changes.

2.5 DESIGN VEHICLE

The minimum design vehicle for all locations is an aerial platform fire truck, with dimensions provided by the Saskatoon Fire Department.

For turns between 23rd Street East and Idylwyld Drive North, a city bus (B-12) is considered a design vehicle due to the presence of bus routes. The intercity bus terminal on 23rd Street East was permanently closed during the study, and an intercity bus is accordingly no longer considered a design vehicle.

Idylwyld Drive and 22nd Street West are designated “Pickup and Delivery Routes” by the City of Saskatoon. 22nd Street East and 20th Street West are part of the designated “Arterial Network” for deliveries. The WB-20 truck is considered the design vehicle for turns to and from these streets.

Turns from Idylwyld Drive to a cross street are accommodated in the recommended plan without the design vehicle encroaching onto adjacent lanes on Idylwyld Drive, with two exceptions: the WB-20 truck must

encroach onto two departure lanes, the right turn lane and one through lane, to turn right from Idylwyld Drive southbound to 20th Street West; and the WB-20 must encroach on three departure lanes to turn right from Idylwyld Drive northbound to 20th Street East. Both these conditions currently exist. For the latter case, this turn would be rarely attempted since the nearby off-ramp to 1st Avenue offers a more direct path.

For the low-volume intersections of 21st Street West and 23rd Street West, the design vehicle uses the full pavement width, including encroaching on the opposing lanes on the minor street. In other locations, design vehicle turns are accommodated without encroaching onto opposing traffic lanes on the receiving street, although encroachment onto multiple receiving lanes in the same traffic direction occurs.

For right turns from 22nd Street West to Idylwyld Drive southbound, the WB-20 may complete the turn from the right-hand lane on the departure leg. This turn connects two designated Pickup and Delivery Routes and was designed to accommodate a large truck without inconvenience.

For right turns from 22nd Street East leaving downtown to Idylwyld Drive northbound, the WB-20 truck must swing out to occupy two lanes on the departure leg. The east leg of this intersection is not a designated Pickup and Delivery Route, and large trucks are permitted downtown only in the evening and overnight.

2.6 SIDEWALKS

The Phase 2 Report proposed a minimum sidewalk width of 4.2 m, of which 1.2 m for the furnishing zone, 2.5 m for the clear sidewalk width, and 0.5 m for the frontage zone. At that time, bicycle paths at sidewalk elevation had not yet been contemplated.

Following the Phase 2 Report, bicycle paths were added to the conceptual design. As well, a zoning regime was proposed that would call for a minimum of 1.0 m setback from property line to building edge: this setback is suitable as a designated “frontage zone”. The “frontage zone” is excluded from the clear sidewalk width to accommodate obstructions such as doors that open, and utility meters.

The clear sidewalk width was changed from 2.5 m to 1.8 m in recognition that 1.8 m remains sufficient for two wheelchairs to pass, and that the adjacent bicycle path could be utilized if, on rare occasions, additional space was needed.

Sidewalk dimensions are highly variable along the corridor, as the right of way width is also highly variable. However, Table 2-2 lists the typical and minimum values used through the corridor. In general, the furnishing zone was selected as the component that would vary the most throughout the corridor, absorbing the changes in right of way, while the other sidewalk elements remained closer to the typical values. This design decision was made in consultation with the Steering Committee as a means to prioritize the aesthetic value of the corridor transformation.

**Table 2-2
Sidewalk Design Parameters**

Parameter	TAC GDG (2017)	Saskatoon ATP (2016)	Imagine Idylwyld (Initial)	Imagine Idylwyld (Minimum)	Imagine Idylwyld (Typical)
Total Sidewalk Width	By Context	n/a	Min 4.2 m	4.2 m	5.8 m
Furnishing Zone	0.5 - 3.0 m (s. 6.3.1.3)	n/a	Min 1.2 m	0.6 m	1.2 m
Bicycle Path	1.5-3.0 m (s. 5.3.1.3)	-	-	1.5 m	1.5 m
Tactile Separation	“Should be included”	-	-	0.3 m	0.3 m
Clear Sidewalk Width	Min 1.5 m (s. 6.3.1.2)	2.5 m (p. 42)	Min 2.5 m	1.8 m	1.8 m
Frontage Zone	0.5 - 3.0 m (s. 6.3.1.1)	n/a	Min 0.5 m	0.0 m ¹	1.0 m ²

¹ Zero frontage zone where existing building built to property line

² Located on private property, included through mandatory hardscaped setback

2.6.1 Multi-Use Pathways

Multi-use pathways allow cyclists and pedestrians to share the same space. Multi-use pathways are included in the recommended plan on the west side of Idylwyld Drive from Jamieson Street to 25th Street West, and along Auditorium Avenue from Idylwyld Drive to Midtown Plaza. The desirable minimum pathway width is 4.0 m. This is achieved in new locations except a short section of 3.8 m width near the intersection of Auditorium Avenue and Idylwyld Drive. The width of the pathway is also reduced approaching the CP Railway crossing north of 24th Street to tie into existing pathway, which is narrower.

2.6.2 Boulevards

Boulevards are provided between the sidewalk/bicycle path and the vehicle lanes, also called the furnishing zone. The typical width is a minimum of 1.2 m, however, in some constrained areas the width drops to as little as 0.6 m over short distances.

The GDG, Section 7.7.2, specifies a minimum lateral clearance of 0.5 m from the face of curb to any obstructions, including lamp posts. Lamp posts are spaced at least every 30 m. As part of the detailed

lighting design, it is recommended that the lateral clearance be considered and lamp posts avoided in the areas with insufficient lateral clearance.

2.7 MEDIANS

According to the GDG, medians serve to separate opposing travel directions and as an access management tool. The GDG Section 4.5.5.2 describes the collision rates for an arterial street with 30,000 vehicles per day as decreasing by 52% with the addition of two-way left turn lanes relative to the undivided condition, and 59% with a raised median.

It was not possible to include a continuous raised median as well as accommodate the project minimum design parameters for accommodating cyclists and pedestrians in dedicated space buffered from traffic. For Imagine Idylwyld, medians were deemed to be desirable, however, providing dedicated space for all road users was deemed to be a higher general priority. Raised medians are provided where space permits, and alternating left turn lanes are at all other locations. Alternating left turn lanes are assumed to be equivalent to two-way left turn lanes.

A raised median is included and recommended for the southernmost block of the project to assist with traffic guidance and separation for drivers arriving from the higher speed Idylwyld Freeway.

Adjacent to 23rd Street West, a median was provided because space was available. This median will assist with access management, including physically preventing the prohibited left turns to and from 23rd Street West.

In front of the fire station, a painted median is provided to enable fire truck access.

Median design details and selection of median type for locations not discussed above should be confirmed as part of the detailed design phase.

2.8 BICYCLE CROSSINGS

Each intersection includes a designated bicycle crossing. In general, these crossings include “elephant feet” pavement markings and either a “bend-in” or a “bend-out” configuration as described in the GDG, Section 5.6.3. TAC describes the bend-out option as preferable, including where there are high volumes of pedestrians, or where the intersection is a protected intersection.

For major intersections, a bend-out design with a 6.0 m offset is recommended. For minor intersections, the bend-in design is deemed acceptable.

Traffic control for the bicycle crossings may include yield signs for turning motorists or separate bicycle signal phases. Traffic control should be determined during detailed design.

2.9 SAFETY PERFORMANCE

The recommended plan is based on the engineering standards of care established at the outset of the project as described in Section 1.2, including:

- Accommodating all modes of travel and people of all ages and abilities.
- Designing Idylwyld Drive as an urban street, encouraging driving speeds around 50 km/h.
- Using the most up-to-date engineering design standards, guidelines, and best practices.

The recommended plan includes several design elements from the recent update to the GDG. As with all design work, the recommended plan also includes certain decisions based on engineering judgment with regard to the desired outcomes and constraints of the project.

It is the professional opinion of the designers that the recommended plan will increase the overall safety of the project study area, especially for the most vulnerable users: people walking, using wheelchairs, or riding bicycles. In addition, it is recommended that the City of Saskatoon take advantage of the opportunity afforded by this reconstruction of Idylwyld Drive to study the change in safety performance brought about by the various innovative design elements. This includes:

- Various bicycle crossing designs (bend-in, bend-out, shared crossing),
- Use of tactile separation between designated bicycling area and pedestrian areas of the sidewalk,
- Removal of a median to accommodate active modes in constrained areas,
- Bus stop island treatment,
- Bike box treatment for left turn transition from multi-use pathway to protected cycling lane, and;
- Raised and textured intersection treatment for a constrained multi-modal mixing zone.

3 Intersection Area Design Concepts

3.1 20TH STREET / AVENUE A INTERSECTION AREA

Avenue A is an unusual access type, with only southbound access from Idylwyld Drive, effectively an off-ramp-style access. Northbound traffic on Avenue A cannot access Idylwyld Drive and instead must turn left into an alleyway.

In Phase 2 of the project, a discussion was held with stakeholders regarding a potential closure of Avenue A access. The stakeholders felt that this closure would have unacceptable negative consequences on existing businesses on Avenue A, which rely on delivery by freight truck. Freight trucks could not access Avenue A via the alleyway, nor make a U-Turn to arrive and depart from 19th Street. The option for full closure was therefore not considered further.

However, both stakeholders and the public identified the need to encourage drivers to slow down on the off-ramp. As a traffic calming measure, it is recommended to narrow the off-ramp to 3.0 m in width and raise the intersection of the Avenue A off-ramp and the alley south of 20th^h Street, similar to the intersection of Spadina Crescent and 21st Street East.

Under the recommended plan, bicyclists will be allowed to continue north on Avenue A to complete a connection between River Landing and Idylwyld Drive. This raised intersection will also serve as a small shared space-type area, where geometric and modal conflicts are managed and risks mitigated by low speeds and eye contact. It is recommended that the raised intersection be textured with paving stones or a similar material to reinforce the perception of a low-speed, multi-modal environment.

The 20th Street intersection includes three protected bicycle crossings. These crossings use a bend-out design with a 6.0 m offset. The 20th Street corridor does not feature protected bicycle lanes and is not a designated “all ages and abilities” (AAA) corridor. The bicycle crossing on the south intersection leg is intended to complete an AAA link from Avenue A to Idylwyld Drive. People riding bicycles from Avenue A to Idylwyld Drive northbound would complete a two-stage left turn manoeuvre using this crossing. People riding bicycles eastbound on 20th Street would not be prohibited but are not expected to choose to use this crossing, opting instead to remain in the vehicle lane.

3.2 AUDITORIUM AVENUE INTERSECTION AREA

The Auditorium Avenue intersection is currently controlled by a pedestrian half-signal; westbound traffic faces a stop sign. In many cases, drivers facing a walk light (in the absence of a signal head with a green light) have been observed to treat the signal like an ordinary signal, ignoring the stop sign and proceeding. This creates a potential conflict with pedestrians crossing Auditorium Avenue, who have no signal head and no “don’t walk” indication. For consistency along the corridor, to better accommodate existing behaviour, and to mitigate the risk of a pedestrian conflict on the west leg, conversion to a full signal is recommended.

As part of the recommended plan, the intersection of Auditorium Avenue includes a shared use crossing of Idylwyld Drive and a multi-use pathway connection to Midtown Plaza. This pathway serves to accommodate wheelchairs, strollers, cyclists, and groups of pedestrians accessing Midtown Plaza from Idylwyld Drive. The existing sidewalk is of substandard width, with several obstructions. This multi-use pathway would affect approximately six parallel parking stalls.

It was observed in field visits that most eastbound pedestrians and cyclists arrive at this crossing from the west, through the city-owned parking lot. The shared crossing is placed slightly south of the intersection to better align with cyclist and pedestrian desire lines and avoid requiring eastbound cyclists to bike a short distance against the flow of the southbound bike path on Idylwyld Drive in front of the existing building (Quinn Army Surplus).

It is also recommended that Midtown Plaza be engaged in a conversation to determine the feasibility of relocating the access to the surface parking lot by a few dozen metres to the east, further away from the intersection with Idylwyld Drive, along with construction of the multi-use pathway.

3.3 21ST STREET WEST INTERSECTION AREA

It is recommended that 21st Street West remain accessible for right turns only. No changes to turn restrictions are proposed.

The recommended plan does not include a median on Idylwyld Drive at the 21st Street West intersection. A channelization island is included in the recommended plan to assist with enforcement of the prohibition on left turns. While the design vehicle at this location is a fire truck, and can be accommodated without mounting the curb, a larger vehicle would need to mount the curb to make the turn. Larger vehicles may occasionally be present for local deliveries.

It is recommended that a fully mountable curb for the channelization island be considered in the detailed design phase.

3.4 22ND STREET INTERSECTION AREA

It is recommended to reconfigure 22nd Street to include a single, dedicated left turn lane in each direction, eliminating the shared through-left lanes northbound and southbound. This topic is discussed in the Phase 3 report.

The traffic analysis for this intersection included the right-hand lanes on 22nd Street as right turn-only lanes. This configuration was included to illustrate the potential for these lanes to be used as bus lanes as part of the bus rapid transit project. This configuration was also found to offer better traffic operations in some scenarios than the shared right and through lanes. The recommended plan illustrates the right-hand lanes as shared through and right turn lanes, as they are today. It is recommended that the configuration for the curb lanes on 22nd Street be considered further during detailed design.

The 22nd Street intersection includes protected bicycle crossings northbound and southbound. These crossings use a bend-out design with a 6.0 m offset.

3.5 23RD STREET WEST INTERSECTION AREA

It is recommended that 23rd Street West remain accessible for right turns only. No changes to turn restrictions are proposed. The recommended plan includes a median on Idylwyld Drive to assist with preventing left turns.

A channelization island similar to that proposed for 21st Street West could also be considered. The design vehicle at this location is a fire truck, and could be accommodated without mounting the curb. However, a larger vehicle would need to mount the curb of the channelization island to make the turn. Larger vehicles may occasionally be present for local deliveries. If a channelization island is used, it would need to incorporate a fully mountable curb.

3.6 23RD STREET EAST / JAMIESON STREET INTERSECTION AREA

This intersection has been designed to accommodate cyclists making each combination of connection between four types of designated cycling facilities:

- North Leg: Multi-use pathway connection to Caswell Hill
- East Leg (23rd Street East): Unidirectional protected bike lanes
- South Leg: Proposed Idylwyld Drive unidirectional bicycle paths
- West Leg (Jamison Street): Blairmore Bikeway bicycle boulevard

In the northeast quadrant, any westbound or northbound cyclist must cross Idylwyld Drive. The designated waiting area is at sidewalk elevation, well in front of the stop bar for increased visibility to drivers.

In the southeast quadrant, a bicycle box is used to accommodate people on bicycles arriving from the north and turning east toward Downtown. It is not intended for people arriving from the west in the lane shared with vehicles, although if no queue is present, they could also use the bicycle box.

In the northwest quadrant, a multi-use pathway is proposed running from Idylwyld Drive to the parking lot entrance half a block to the west. In this way, cyclists heading west on the Blairmore Bikeway are accommodated outside the vehicle lanes in the vicinity of the intersection, and transition to riding in mixed traffic at a location with fewer other conflicts and distractions for both drivers and cyclists. This multi-use pathway also enables people riding bicycles from west to the north to access the shared pathway as if making a left turn into the parking lot, rather than turning left at the crosswalk on the near side of the intersection.

Just east of the intersection, the existing protected bicycle lane interacts with a bus stop. The current configuration calls for the bus to pull to the curb and for people on bicycles to wait for the bus. It is likely that many cyclists choose to pass the bus in the lanes shared with vehicles. As described in the GDG, Section

5.7.2, a bus island can prevent conflicts between cyclists and buses. A bus island is recommended for this location. A bus island would introduce a short crosswalk, crossing the bike lane, between the main sidewalk and the bus stop. It is recommended that this crosswalk operate and be controlled as a typical, although short, crosswalk, where bicyclists yield to pedestrians accessing the bus stop.

It is recommended that the detailed design adhere as closely as reasonable to the intent of the functional plan, accommodating cyclists for all movements including passing behind the bus stop.

3.7 24TH STREET EAST INTERSECTION AREA

One new turn restriction is recommended: prohibiting northbound traffic on Idylwyld Drive from turning left into the private parking lot opposite 24th Street East.

- Geometrically, there is not sufficient space for a dedicated left turn lane. If the turn was allowed, it would be the only location on Idylwyld Drive in the study area that left turns would be permitted from the main driving lanes.
- Alternate access to the parking lot is available from Jamieson Street. Left turns to Jamieson Street will include a dedicated left turn lane. There is no additional travel distance for this alternate access.
- The prohibition of northbound left turns enables improved signal coordination for southbound traffic turning left.

The improved signal coordination is due to the elimination of the yellow-trap risk if lagging protected left turns are used. If left turns were permitted northbound, southbound traffic would have to have their protected left turn phase at the beginning of their green phase. If northbound traffic is not permitted to turn left, southbound traffic could have their protected left turn phase at the end of the green time.

In both the current and proposed traffic signal coordination schemes, which are constrained by the railway crossing and tightly spaced intersections, traffic turning left from 25th Street East arrives at the 24th Street intersection while there is a red light for southbound traffic. When the signal turns green, nearly every car in the queue has recently arrived from 25th Street East. Very few of those drivers would be interested in turning left to go eastbound on 24th Street. The left turn arrow would be wasted. By enabling the protected left turn to happen at the end of the green phase, it is more likely that drivers who need it would be present to use it. This phasing would also serve to help clear the queues from the railway crossing.

3.8 25TH STREET INTERSECTION AREA

The Canadian Pacific Railway runs through the intersection of Idylwyld Drive and 25th Street East. The intersection with 25th Street West is about 30 m away. The current configuration dates to 2013 along with the extension of 25th Street from 1st Avenue to Idylwyld Drive. The geometric design of these two adjacent intersections is constrained by the railway crossing and related Transport Canada and railway company requirements. As requested by the City of Saskatoon, geometric design changes to these intersections are excluded from the scope of this project. Minor signal timing changes are included.

4 Mobility

4.1 CONDITIONS FOR DRIVERS

Two methods were used to evaluate traffic flow: Highway Capacity Manual 2010 (HCM 2010) using PTV Vistro software, and microsimulation using PTV Vissim software. Details on assumptions and methods are included in the Phase 2 Report. Sections 4.1.1 through 4.1.3 below describe the traffic signal timing parameters achieved and recommended. Sections 4.1.4 through 4.1.7 summarize key comparative engineering traffic metrics at each intersection.

All analysis assumes there is no train crossing event.

4.1.1 Cycle Time

A target maximum of 90 s was established in Phase 2 as described in Appendix B. The target cycle time was not achievable given the traffic volumes and other constraints; however, cycle times were reduced relative to existing conditions. Table 4-1 outlines the current, target, and proposed cycle times for the current traffic volume scenarios.

Table 4-1
Signal Cycle Time

Scenario	Current	Target	Achieved
AM Peak	125 s	90 s	100 s
PM Peak	130 s	90 s	115 s

For the 400,000 population forecast traffic volume scenarios, cycle times of 115 s for the AM Peak and 110 s for the PM Peak were used as determined by optimization.

It is recommended that cycle times be minimized to the extent possible upon implementation of the recommended plan. If a cycle time of 120 s is deemed necessary in the future, it is recommended that a half-cycle of 60 s be considered at Auditorium Avenue, to minimize pedestrian wait times and improve the connection between Midtown Plaza and Riversdale.

4.1.2 Clearance Intervals

Pedestrian clearance intervals were established at each intersection based on a walking speed of 1.2 m/s. Pedestrian clearance intervals are discussed further in Section 4.2.5. All-red and amber clearance intervals were established in Phase 2 and used for planning purposes. Actual clearance intervals should be calculated based on actual geometry following detailed design.

4.1.3 Left Turn Lane Phasing

All left turns in the recommended plan are assumed to have permissive or protected-permissive phasing. Split phasing and protected-only left turn phasing are not used.

4.1.4 Level of Service

Table 4-2 and Table 4-3 summarize the overall intersection level of service for each scenario. Details for each approach and movement are included in Appendix C for the existing layout and Appendix D for the recommended layout.

**Table 4-2
Level of Service Comparison, AM Peak**

Intersection	Current Traffic Volume		Traffic at 400,000 City Population	
	Current Configuration	Recommended Plan	Current Configuration	Recommended Plan
20th Street	B	B	C	C
Auditorium Ave	A	A	A	B
22nd Street	E	C	F	E
23rd St. E / Jamieson	B	C	C	C
24th Street East	B	B	C	B
25th Street East	B	B	C	C

**Table 4-3
Level of Service Comparison, PM Peak**

Intersection	Current Traffic Volume		Traffic at 400,000 City Population	
	Current Configuration	Recommended Plan	Current Configuration	Recommended Plan
20th Street	C	C	D	D
Auditorium Ave	A	A	A	A
22nd Street	E	D	F	F
23rd St. E / Jamieson	B	B	C	C
24th Street East	C	B	E	C
25th Street East	C	C	D	C

4.1.5 Average Delay

Table 4-4 and Table 4-5 summarize the average intersection delay for each scenario. Details for each approach and movement are included in Appendix C for the existing layout and Appendix D for the recommended layout.

**Table 4-4
Average Delay Comparison, AM Peak**

Intersection	Current Traffic Volume		Traffic at 400,000 City Population	
	Current Configuration	Recommended Plan	Current Configuration	Recommended Plan
20th Street	17 s	18 s	24 s	24 s
Auditorium Ave	3 s	9 s	6 s	11 s
22nd Street	68 s	32 s	128 s	56 s
23rd St. E / Jamieson	15 s	24 s	22 s	25 s
24th Street East	13 s	11 s	23 s	14 s
25th Street East	16 s	14 s	28 s	27 s

**Table 4-5
Average Delay Comparison, PM Peak**

Intersection	Current Traffic Volume		Traffic at 400,000 City Population	
	Current Configuration	Recommended Plan	Current Configuration	Recommended Plan
20th Street	28 s	21 s	40 s	41 s
Auditorium Ave	6 s	2 s	8 s	7 s
22nd Street	72 s	49 s	135 s	83 s
23rd St. E / Jamieson	18 s	17 s	34 s	28 s
24th Street East	28 s	12 s	64 s	33 s
25th Street East	25 s	22 s	38 s	35 s

4.1.6 Volume to Capacity Ratio

Table 4-6 and Table 4-7 summarize the average volume to capacity ratio for each scenario. Details for each approach and movement are included in Appendix C for the existing layout and Appendix D for the recommended layout.

**Table 4-6
Volume to Capacity Ratio Comparison, AM Peak**

Intersection	Current Traffic Volume		Traffic at 400,000 City Population	
	Current Configuration	Recommended Plan	Current Configuration	Recommended Plan
20th Street	0.51	0.53	0.79	0.79
Auditorium Ave	0.34	0.51	0.42	0.61
22nd Street	0.83	0.74	1.10	0.54
23rd St. E / Jamieson	0.52	0.61	0.82	0.71
24th Street East	0.65	0.66	0.82	0.82
25th Street East	0.61	0.64	0.86	0.90

**Table 4-7
Volume to Capacity Ratio Comparison, PM Peak**

Intersection	Current Traffic Volume		Traffic at 400,000 City Population	
	Current Configuration	Recommended Plan	Current Configuration	Recommended Plan
20th Street	0.76	0.78	1.06	1.08
Auditorium Ave	0.39	0.55	0.50	0.70
22nd Street	1.02	1.04	1.33	1.12
23rd St. E / Jamieson	0.60	0.61	1.10	0.71
24th Street East	0.89	0.80	1.22	1.07
25th Street East	0.74	0.77	0.68	0.98

4.1.7 Travel Time

A full microsimulation was completed for the afternoon peak period with current traffic conditions for the existing and recommended configurations. Corridor travel times from the model are summarized in Table 4-8. Details on the microsimulation procedures and results can be found in Appendix E.

**Table 4-8
Simulated Corridor Travel Times, PM Peak**

Travel Segment	Existing Configuration	Recommended Configuration
Northbound (19th Street to 25th Street West)	132 s	130 s
Southbound (25th Street West to 19th Street)	136 s	118 s

Microsimulation results show a slight improvement but little difference in travel time between the existing and recommended configurations. To compare the simulation of existing conditions to conditions in the field, a series of test drives were undertaken during the afternoon peak period in December 2016. Travel time was recoded based on two travel behaviours. “Aggressive” behaviour included making several lane changes, always selecting the shortest queue, and using the right-hand lane for passing. “Cautious” behaviour involved travelling in the same lane from start to finish, except southbound, where one lane change was required. Table 4-9 summarizes the results.

**Table 4-9
Observed Travel Times, PM Peak**

Travel Segment	Aggressive Behaviour	Cautious Behaviour
Northbound (19th Street to 25th Street West)	194 s	359 s
Southbound (25th Street West to 19th Street)	132 s	302 s

Microsimulation appears to better represent the “aggressive” driver behaviour. The software enables drivers to complete lane changes as often as necessary to reduce the travel time. Under existing conditions, making multiple lane changes can benefit travel time significantly.

While field conditions cannot be measured for the recommended configuration, the nature of the design limits the opportunity to be rewarded by aggressive driving behaviour. With two continuous through lanes from start to finish in both directions, no through lanes shared with left turning traffic, and no core lanes that end at intersections, there is little incentive to make lane changes. Under the recommended configuration, traffic is likely to balance itself evenly into the two main lanes, optimizing capacity for all drivers without rewarding aggressiveness.

4.2 CONDITIONS FOR PEOPLE WALKING

4.2.1 Sidewalk Width

The sidewalks along Idylwyld Drive south of 24th Street are narrow, ranging from 1.8 m to 2.3 m, but lampposts, signposts and other obstructions render them effectively much narrower.

The recommended plan includes significantly wider sidewalks, separated from vehicles by both landscaping and a bicycle path.

With the removal of channelization islands at three intersections, large pedestrian spaces are created, opening opportunities for landscaping, benches, and artwork.

4.2.2 Accessibility Ramps

Existing conditions include a mixture of accessible and non-accessible pedestrian crossings. In many locations wheelchairs and strollers are not provided with a curb ramp.

The recommended plan includes accessibility ramps at every corner.

4.2.3 Maximum Wait at Intersections

As discussed in Section 4.1.1 above, the traffic signal cycle time is also equivalent to the maximum wait time for pedestrians.

**Table 4-10
Maximum Pedestrian Wait**

Scenario	Current	Target	Achieved
AM Peak	125 s	90 s	100 s
PM Peak	130 s	90 s	115 s

4.2.4 Crosswalk Length

In most cases, crosswalk distances were reduced from the existing conditions. Table 4-11 summarizes the current and proposed crossing distances. In cases where channelization islands are present, the total crossing distance is shown as the main crosswalk length plus the distance to cross any right turn lanes, but does not include the distance within the island where a pedestrian is not exposed to traffic conflicts.

**Table 4-11
Crosswalk Length Comparison**

Intersection	Intersection Leg	Existing Crossing Distance	Proposed Crossing Distance
20th Street	East	20 m + 6 m	21 m
	West	20 m	17 m
	South	29 m	25 m
	North	30 m + 6 m	27 m
Auditorium Avenue	South	26 m	16 m
	West	20 m	10 m
22nd Street	East	24 m + 12 m	26 m
	West	26 m + 12 m	26 m
	South	23 m + 12 m	22 m
	North	23 m + 12 m	22 m
23rd Street East / Jamieson Street	East	29 m	20 m
	West	18 m	17 m
	South	27 m	25 m
	North	26 m	20 m
24th Street East	East	15 m	19 m
	West	12 m	12 m
	South	27 m	20 m
	North	23 m	19 m
25th Street East	East	16 m + 14 m	16 m + 14 m
	North	24 m + 7 m	24 m + 7 m

4.2.5 Crossing Time

Under current conditions, pedestrians must walk between 1.5 m/s and 1.9 m/s. In the Phase 2 Report, a target of 1.2 m/s was set for the maximum walking speed. This target value was used for all crosswalks. Table 4-12 summarizes the minimum pedestrian clearance interval used for analysis.

**Table 4-12
Pedestrian Clearance Interval**

Intersection	Intersection Leg	Associated Vehicle Direction	Crossing Distance	Minimum PCI
20th Street	East	Northbound	21 m	18 s
	West	Southbound	17 m	14 s
	South	Eastbound	25 m	21 s
	North	Westbound	27 m	23 s
Auditorium	South	Westbound	16 m	13 s
	West	Northbound	10 m	10 s
22nd Street	East	Northbound	26 m	22 s
	West	Southbound	26 m	22 s
	South	Eastbound	22 m	18 s
	North	Westbound	22 m	18 s
23rd Street East / Jamieson Street	East	Northbound	20 m	17 s
	West	Southbound	17 m	14 s
	South	Eastbound	25 m	21 s
	North	Westbound	20 m	17 s
24th Street East	East	Northbound	19 m	16 s
	West*	Southbound	12 m	10 s
	South	Eastbound	20 m	17 s
	North	Westbound	19 m	16 s
25th Street East	East	Northbound	16 m	13 s
	North	Westbound	24 m	20 s

*Driveway crossing without pedestrian signal head.

Stated another way: the current design assumes pedestrians can clear a crosswalk twenty metres long in as little as ten seconds. The proposed design accommodates pedestrians who need sixteen seconds to cover the same distance. Table 4-13 summarizes the comparison.

Table 4-13
Time Accommodated to Clear 20 m Crosswalk

Current Worst Case	Current Average	Proposed Design
10 s	13 s	16 s

4.3 CONDITIONS FOR PEOPLE RIDING BICYCLES

4.3.1 Facility Type

Idylwyld Drive does not currently have dedicated infrastructure for people riding bicycles. Although not prohibited, it is very rare for a person riding a bicycle to choose to ride with traffic on Idylwyld Drive. Cyclists that do use the corridor are generally observed riding illegally on the sidewalk.

The recommended plan incorporates bicycle paths as a designated area of the sidewalk, separated from the vehicle lanes by a landscaping buffer. The bicycle path is recommended to be separated from the pedestrian component of the sidewalk by a tactile surface, which could be similar to a rumble strip. This configuration is considered an AAA facility type, and will form one component of the downtown AAA network. This style of accommodation is intended for lower speed cyclists and provides connectivity to the surrounding neighbourhoods as well as access to properties along Idylwyld Drive itself.

This facility type is not suitable for cyclists desiring a high-speed through route. Adjacent streets such as Avenue C would be a more suitable option for these types of trips.

4.3.2 Intersection Accommodation

Accommodation of cyclists at intersections is accomplished through dedicated bicycle crossings in most cases, as well as a shared pedestrian-bicycle crossing at Auditorium Avenue. Intersection layout is discussed further in Sections 3.2 through 3.8.

4.4 CONDITIONS FOR PEOPLE USING TRANSIT

There are currently no bus stops along Idylwyld Drive within the study corridor. There are bus stops, however, adjacent to the study area on 20th Street, 22nd Street, 23rd Street, 25th Street, and just north of the study boundary on Idylwyld Drive itself. A future bus rapid transit station is also planned on 22nd Street near the intersection with Idylwyld Drive. Within the study area, transit users would be either walking, riding a bicycle, or using a wheelchair to access a bus stop. Conditions for transit users are therefore better described in the sections above relating to these modes of travel.

As discussed in Section 3.6, modifications to the existing bus stop on 23rd Street East are recommended. These modifications, including construction of a bus stop island, are intended to reduce conflicts between buses and bicycles. A bus island would introduce a short crosswalk, crossing the bike lane, between the main sidewalk and the bus stop. It is recommended that this crosswalk operate and be controlled as a typical, although short, crosswalk, where bicyclists yield to pedestrians accessing the bus stop.

4.5 CONDITIONS FOR FREIGHT TRUCKS

Saskatoon has two classifications of freight truck route: Long Haul Vehicle Routes accommodate all legal freight truck sizes including multiple-trailer trucks, while Pick Up and Delivery Vehicle Routes accommodate single-unit and single-trailer freight trucks. In addition to the truck routes, freight trucks making local deliveries must use designated Arterial Road Network links to travel to and from their destination if the destination is off a designated truck route. The Central Business District has additional freight truck usage regulations, prohibiting certain trucks during the daytime.

Since the completion of Circle Drive South, Idylwyld Drive is no longer part of the Long Haul Vehicle Route. It does remain, however, part of the Pick Up and Delivery Network, and is a designated route for freight trucks with an origin or destination within the city. In addition to Idylwyld Drive itself, 22nd Street West is part of the Pickup and Delivery Network, while 20th Street, 22nd Street East, and 25th Street East are part of the Arterial Road network.

Freight trucks are accommodated in the design based on the street designation. For turns between designated Pick Up and Delivery Vehicle Routes, 22nd Street West and Idylwyld Drive North and South, a large single-trailer truck (WB-20) will be able to turn left and right from their own lane, but may have to use multiple lanes on the receiving street.

For turns to and from designated Arterial Road Network links, truck drivers may need to swing out on the departure leg to be able to complete right hand turns. This conditions currently exists for most such right turns. In two locations, this condition is being created where previously it did not exist: westbound to northbound right turns from 20th Street to Idylwyld Drive, and westbound to northbound right turns from 22nd Street to Idylwyld Drive. In both these cases, this change is being made as a consequence of the project goal to prioritize pedestrians. Truck turning volumes are low, and as streets that depart the Central Business District, large trucks are not permitted before 6:00 p.m.

For other streets, freight trucks are provided with basic access. Basic access means a freight truck is accommodated, but may be required to use left-hand turns only, or to encroach on opposing lanes on low volume streets.

Freight truck accommodation is also discussed in Section 2.5. Details of truck accommodation should be confirmed in detailed design; however, it is recommended that the emphasis on pedestrian priority over freight truck accommodation be maintained.

5 Summary of Recommendations

5.1 RECOMMENDED FUNCTIONAL DESIGN

The recommended Functional Design Plan, included as Appendix A, summarizes and illustrates the overall recommended plan. Specific recommendations include:

1. Provide four basic, continuous lanes through the study area, such that the two lanes approaching the study area from the north be continuous with the two lanes departing the study area toward the south, and vice-versa, to which auxiliary lanes are added for individual locations as shown in Appendix A.
2. Provide a raised median on the block from 20th Street to Auditorium Avenue to assist with separating and guiding traffic transitioning from Idylwyld Freeway.
3. Provide a raised median adjacent to 23rd Street West to assist with access management and left turn prevention.
4. Reconfigure Idylwyld Drive at 22nd Street to include a single, dedicated left turn lane in each direction, eliminating the shared through-and-left lanes northbound and southbound to enable the removal of split signal phases.
5. Remove all channelized right turn islands except at 25th Street East, where the railway crossing constrains opportunities for design changes.
6. Install accessibility ramps at every corner.
7. Incorporate bicycle paths as a designated area of the sidewalk, separated from the vehicle lanes by a landscaping buffer, and separated from the pedestrian component of the sidewalk by a tactile surface, similar to a rumble strip.
8. Construct bicycle crossings at major intersections using a bend-out configuration with 6.0 m minimum offset. For minor intersections, the bend-in design is deemed acceptable.
9. Convert the intersection of Idylwyld Drive and Auditorium Avenue from a pedestrian half signal to a full traffic signal.
10. Include a multi-modal crossing of Idylwyld Drive at Auditorium Avenue and a multi-use pathway connection to Midtown Plaza to accommodate wheelchairs, strollers, cyclists, and groups of pedestrians accessing Midtown Plaza from west of Idylwyld Drive.
11. As a traffic calming measure, narrow the off-ramp lane from Idylwyld Drive southbound to Avenue A to 3.0 m in width and raise the intersection of the Avenue A off-ramp and the alley south of 20th Street, similar to the intersection of Spadina Crescent and 21st Street East. It is also recommended that the raised intersection be textured with paving stones or a similar material to reinforce the perception of a low-speed, multi-modal environment.
12. Maintain the existing configuration as right-turns access only at 21st Street West and 23rd Street West only, and maintain the existing left turn prohibition from 20th Street East toward Senator Sid Buckwold Bridge.
13. Prohibit northbound traffic on Idylwyld Drive from turning left into the private parking lot opposite 24th Street East.

14. Modify the existing bus stop on 23rd Street East to include a bus stop island complete with a short crosswalk where bicyclists yield to pedestrians accessing the bus stop.

5.2 FUTURE STUDY

Following this conceptual and functional planning study, it is expected that this project will proceed to a detailed design phase. The following are among the considerations recommended to the detailed design team:

- Consider the lane usage designation for the curb lanes on 22nd Street, including considering the state of bus rapid transit planning on 22nd Street at that time.
- Consider a fully mountable curb for the channelization island at 21st Street West.
- Ensure the detailed design for the 23rd Street East / Jamieson Street intersection adheres as closely as reasonable to the intent of the functional plan, accommodating cyclists for all movements.fmu
- Engage Midtown Plaza in a conversation to determine the feasibility of relocating the access to the surface parking slightly to the east, further away from the intersection with Idylwyld Drive.
- Confirm details of truck and other design vehicle accommodation; however, it is recommended that the emphasis on pedestrian priority over freight truck accommodation be maintained.
- Ensure signal cycle times are minimized to the extent possible upon implementation. If a cycle time of 120 s is deemed necessary, it is recommended that a half-cycle of 60 s be considered at Auditorium Avenue to minimize pedestrian wait times and improve the connection between Midtown Plaza and Riversdale.
- Update signal timing parameters including clearance intervals based on actual geometry following detailed design.

Further, as discussed in Section 2.9, it is recommended that the City of Saskatoon take advantage of the opportunity afforded by this reconstruction of Idylwyld Drive to study the change in safety performance brought about by the various innovative design elements, in order to assist with future multi-modal street planning projects.

REPORT

References

Institute of Transportation Engineers. *Designing Walkable Urban Thoroughfares: A Context Sensitive Approach*. ITE. Washington, D.C., 2010.

National Association of City Transportation Officials *Urban Street Design Guide*. NACTO. New York, 2013.

Transportation Association of Canada. *Geometric Design Guide for Canadian Roads*. TAC. Ottawa, 2017.

Transportation Association of Canada. *Bikeway Traffic Control Guidelines for Canada, 2nd Edition*. TAC. Ottawa, 2012.

Transportation Association of Canada. *Pedestrian Crossing Control Guide*. TAC. Ottawa, 2012.

Transportation Association of Canada. *Geometric Design Guide for Canadian Roads*. TAC. Ottawa, 1999.

Transportation Association of Canada and the Institute of Transportation Engineers. *Canadian Capacity Guide for Signalized Intersections, 3rd Edition*. TAC and ITE. Ottawa, 2008.

Transportation Research Board of the National Academies. *Highway Capacity Manual 2010*. TRB. Washington, D.C., 2010.



REPORT

Certification Page

This report was prepared for the account of HOK, Inc. and summarizes our work on the transportation-related components of the Idylwyld Drive Comprehensive Corridor Project and Streetscape Concept, also known as Imagine Idylwyld. The services provided by Associated Engineering (Sask.) Ltd. in the preparation of this report were conducted in a manner consistent with the level of skill ordinarily exercised by members of the profession currently practicing under similar conditions. No other warranty expressed or implied is made.

Respectfully submitted,
Associated Engineering (Sask.) Ltd.

Prepared By:



Kevin Sturgeon, P.Eng.
Project Manager

Reviewed By:



Bryan Petzold, P.Eng., M.Sc.
Vice-President,
Transportation Planning and Traffic Operations

ASSOCIATION OF PROFESSIONAL ENGINEERS AND GEOSCIENTISTS OF SASKATCHEWAN CERTIFICATE OF AUTHORIZATION ASSOCIATED ENGINEERING (SASK.) LTD. NUMBER C116 Permission to Consult Held By: Discipline Sask. Reg. No. Signature <i>Transportation Planning 06372 2110-Kaulay</i>		

ASSOCIATED ENGINEERING QUALITY MANAGEMENT SIGN-OFF	
Signature:	<i>[Signature]</i>
Date:	<i>May 30, 2014</i>



Associated
Engineering

GLOBAL PERSPECTIVE.
LOCAL FOCUS.

REPORT

Appendix A – Functional Corridor Plans

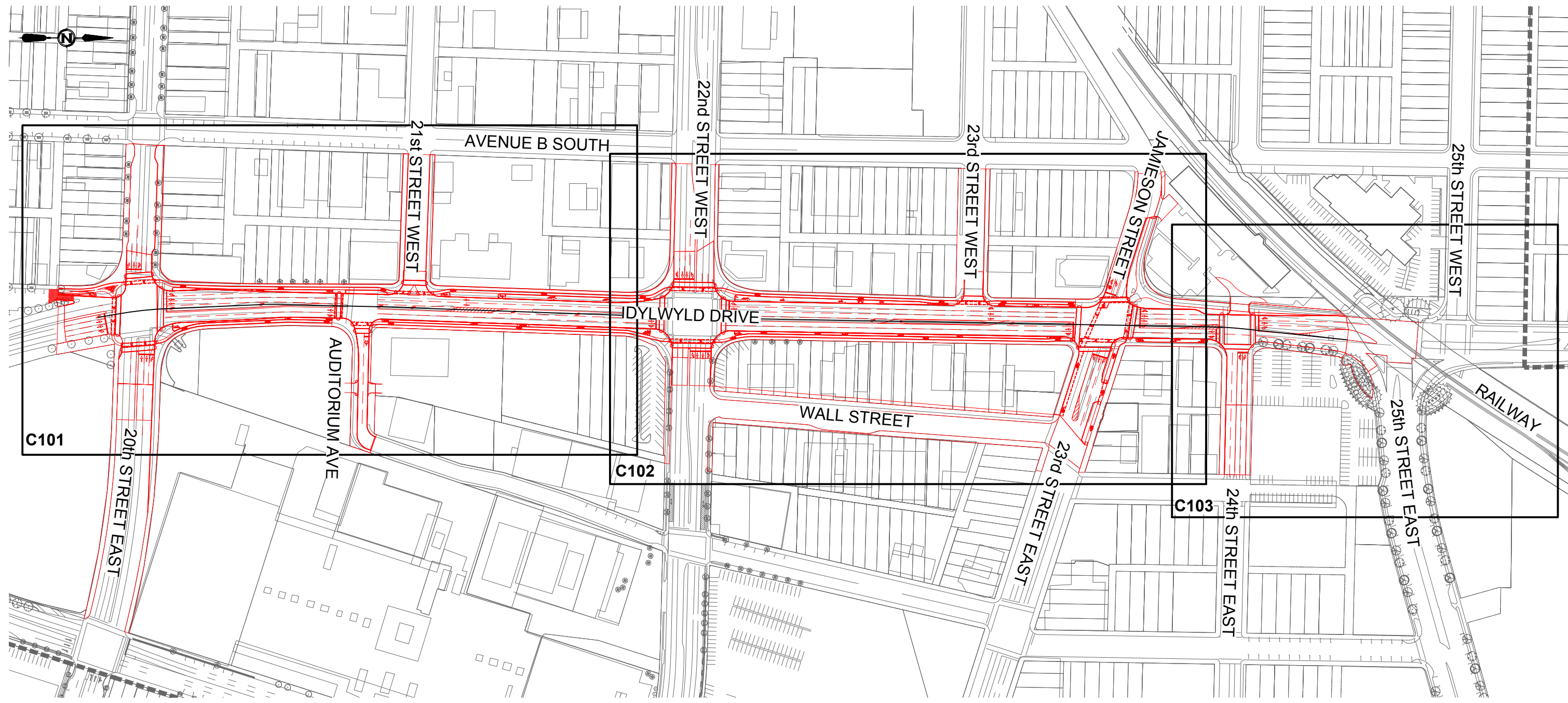

KEY PLAN 1:2500

W:\vel_infrastructure\tasks\20164867-16\w\dwg\2018-04-12-Final_Draft\100_Civil\4867-00-c-001-301.dwg
DATE: 2018-05-16, Chris Durcan



AE PROJECT No.	20164867
SCALE	AS SHOWN
APPROVED	K. STURGEON
DATE	2018MAY16
REV	A
DESCRIPTION	FINAL

FUNCTIONAL PLAN
CITY OF SASKATOON
HOK, INC

TRANSPORTATION
IDYLWYLD DRIVE
RECOMMENDED PLAN

FOR PLANNING ONLY
NOT FOR CONSTRUCTION

DWG No. 4867-00-C-001

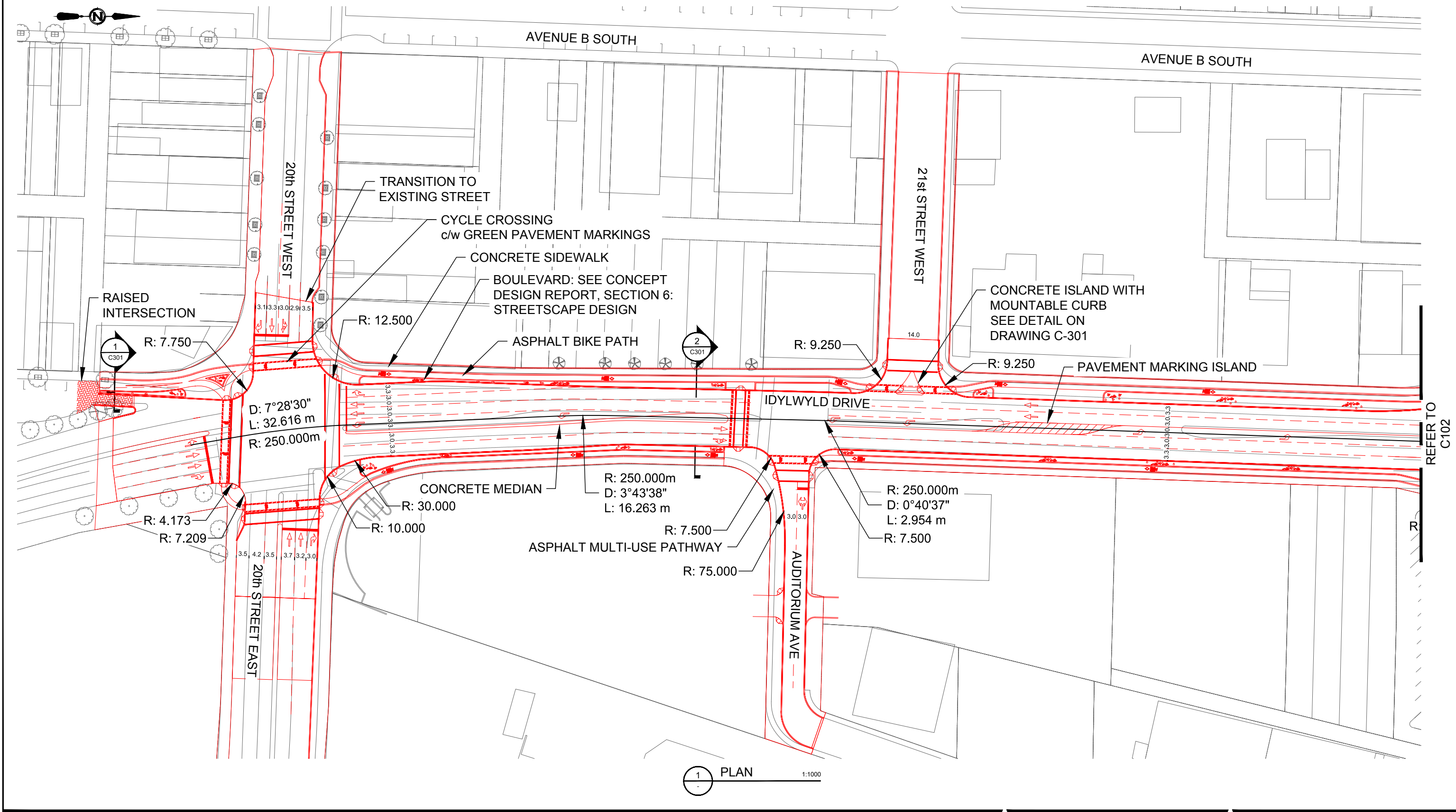

1 PLAN 1:1000

W:\vel_infrastructure\tasks\20164867-16\dwg\2018-04-12-Final_Draft\100_Civil\4867-00-c-001-301.dwg
DATE: 2018-05-16, Chris Durcan



AE PROJECT No.	20164867
SCALE	AS SHOWN
APPROVED	K. STURGEON
DATE	2018MAY16
REV	A
DESCRIPTION	FINAL

FUNCTIONAL PLAN
CITY OF SASKATOON HOK, INC

TRANSPORTATION IDYLWYLD DRIVE RECOMMENDED PLAN
--

FOR PLANNING ONLY
NOT FOR CONSTRUCTION

DWG No. 4867-00-C-101

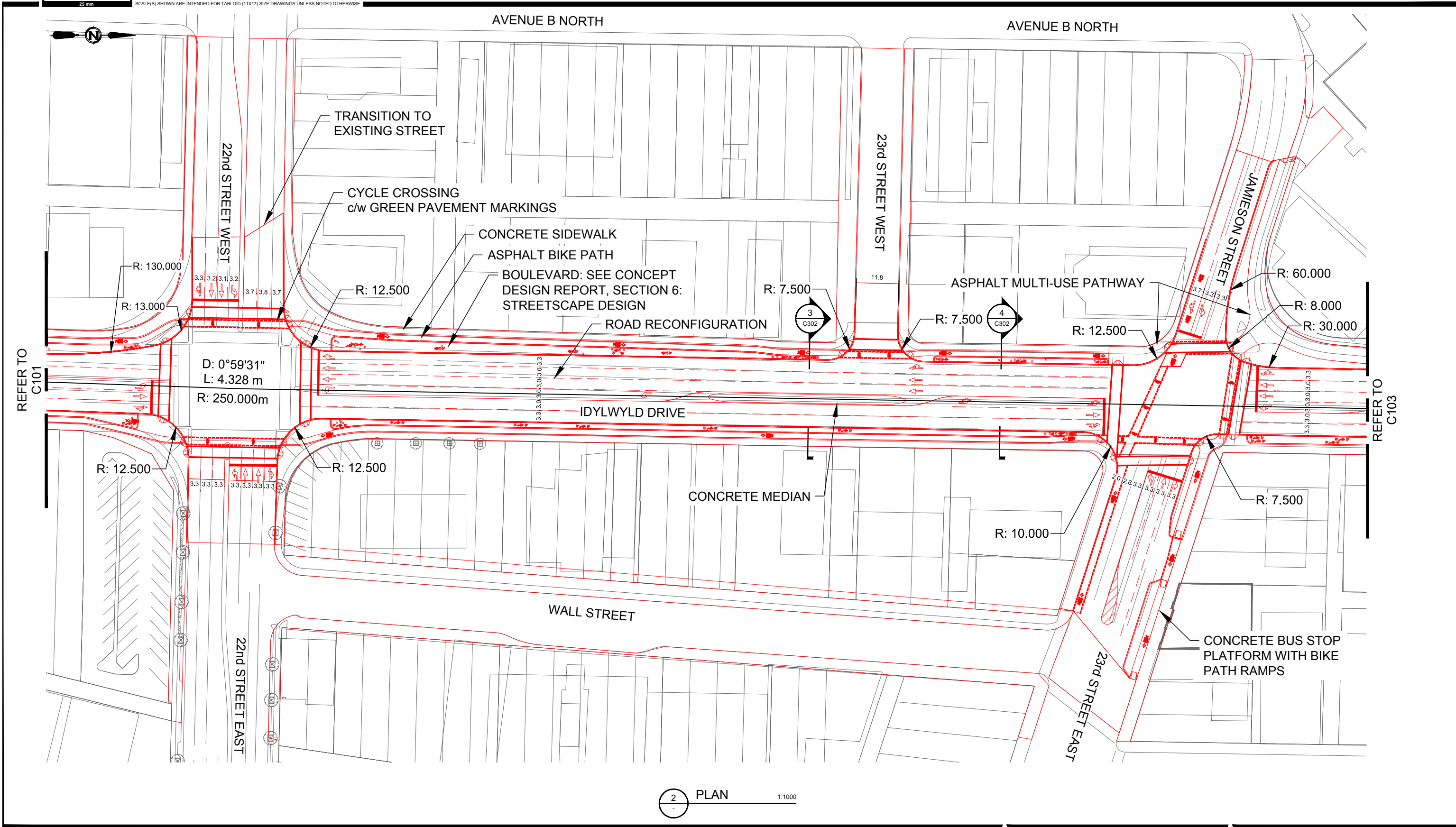

2 PLAN 1:1000

W:\a\Infrastructure\sask20164867\idylwyld\2018-04-12\Final_Draft\100_Civil\4867-00-c-001-301.dwg
 DATE: 2018-05-16, Chris Duncan



AE PROJECT No.	20164867	FUNCTIONAL PLAN
SCALE	AS SHOWN	
APPROVED	K. STURGEON	
DATE	2018MAY16	
REV	A	
DESCRIPTION	FINAL	CITY OF SASKATOON HOK, INC
		TRANSPORTATION IDYLWYLD DRIVE RECOMMENDED PLAN

FOR PLANNING ONLY
NOT FOR CONSTRUCTION

DWG No. 4867-00-C-102

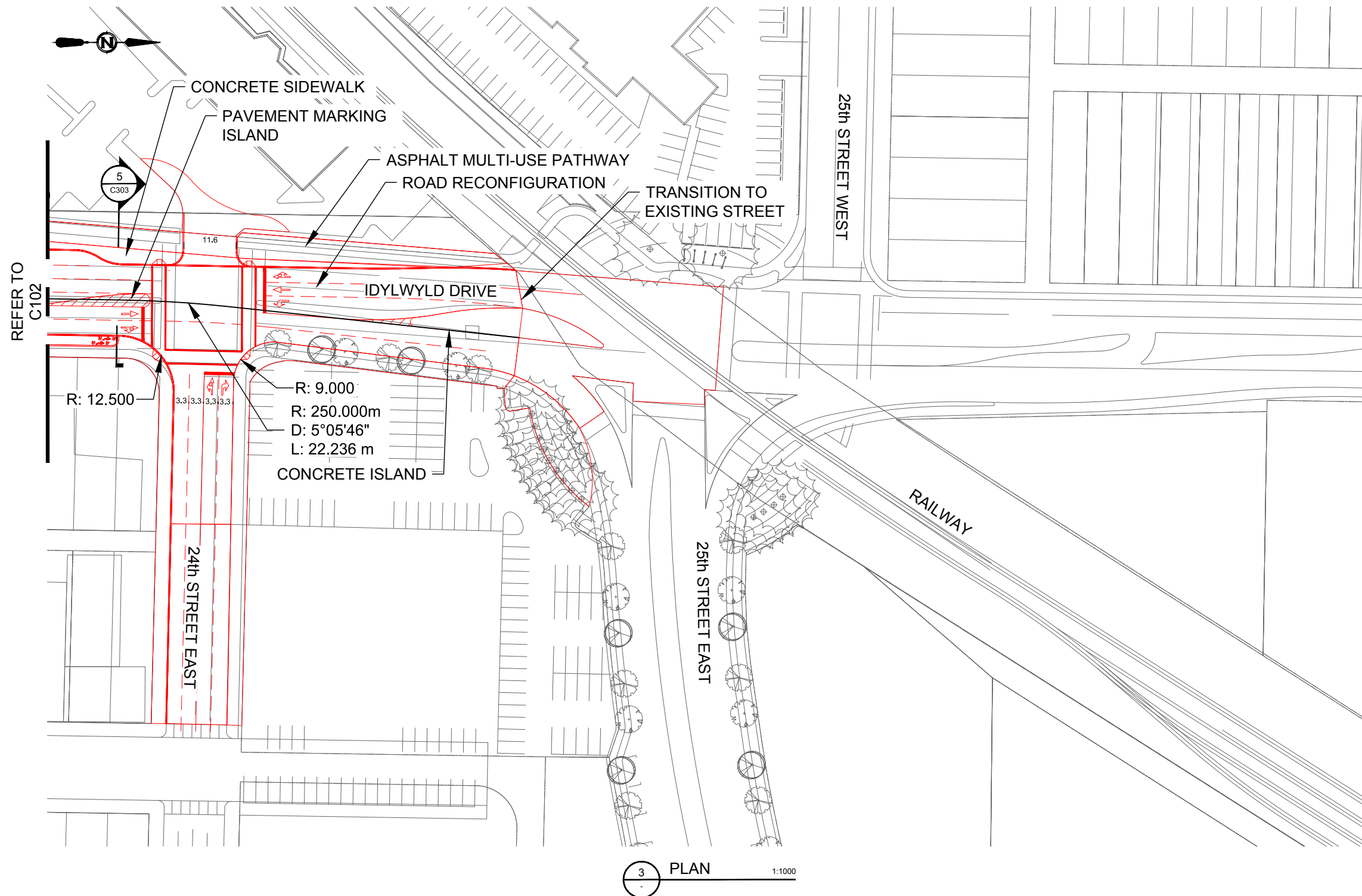

3 PLAN 1:1000

W:\a\Infrastructure\Sasko\20164867\Idylwyld\2018-04-12\Final_Draft\100_Civil\4867-00-c-001-301.dwg
DATE: 2018-05-16, Chris Duncan



AE PROJECT No.	20164867
SCALE	AS SHOWN
APPROVED	K. STURGEON
DATE	2018MAY16
REV	A
DESCRIPTION	FINAL

FUNCTIONAL PLAN
CITY OF SASKATOON
HOK, INC

TRANSPORTATION
IDYLWYLD DRIVE
RECOMMENDED PLAN

FOR PLANNING ONLY
NOT FOR CONSTRUCTION

DWG No. 4867-00-C-103

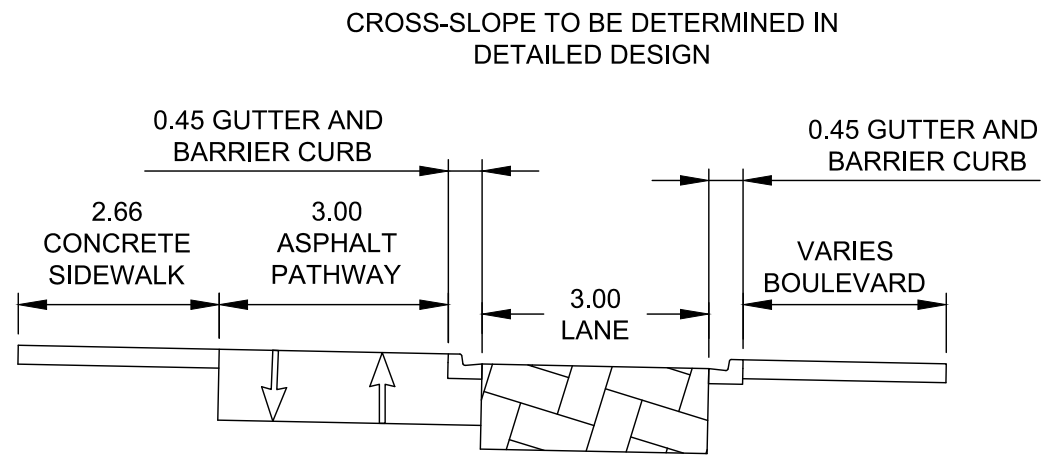

NOTES:
1. REFER TO CITY OF SASKATOON STANDARD DRAWING 102-0001-002r001 FOR CURB AND BOULEVARD DETAILS.

1 SECTION 1:100
AVENUE A SOUTH - SOUTH OF 20TH STREET WEST

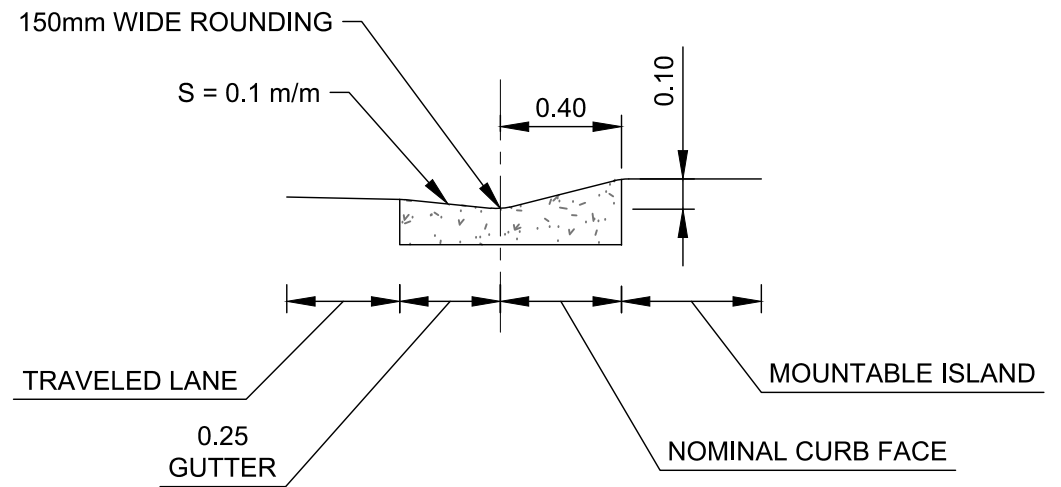

NOTES:
1. MOUNTABLE CURB DESIGN AS PER TAC GEOMETRIC DESIGN FOR CANADIAN ROADS (2017)

1 DETAIL 1:25
MOUNTABLE CURB

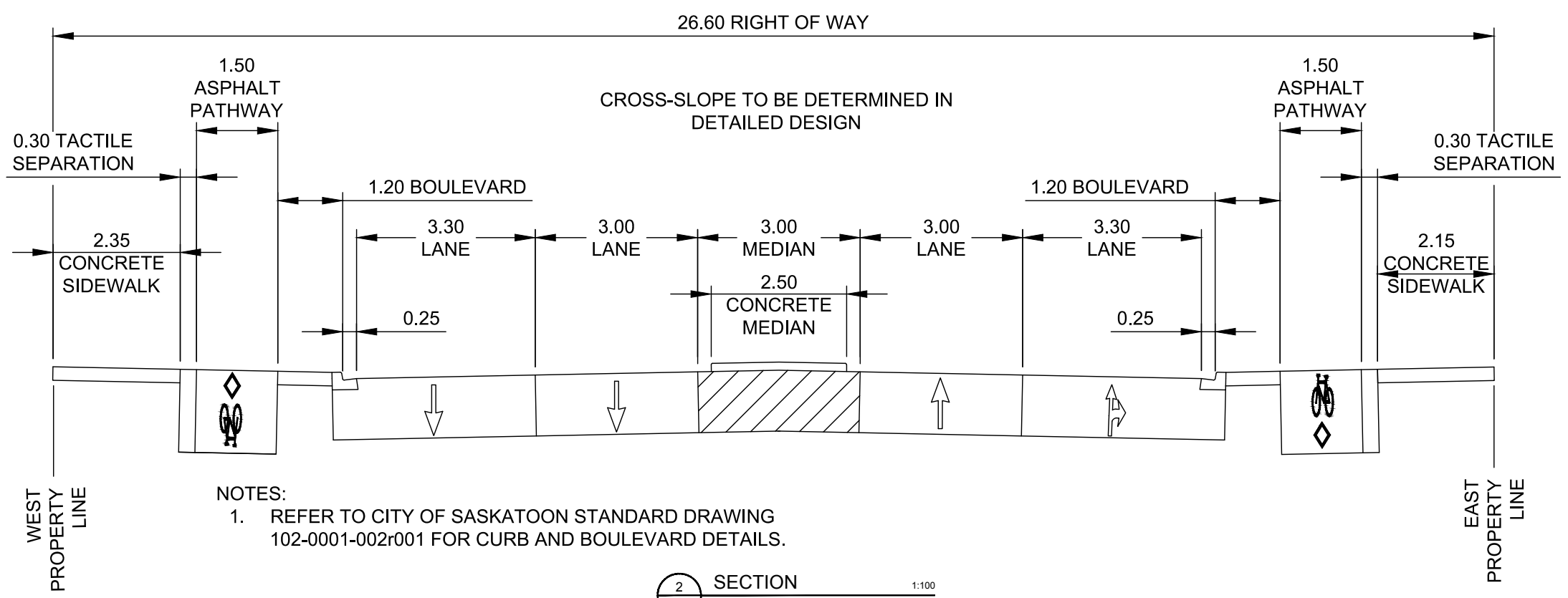

NOTES:
1. REFER TO CITY OF SASKATOON STANDARD DRAWING 102-0001-002r001 FOR CURB AND BOULEVARD DETAILS.

2 SECTION 1:100
30 m SOUTH OF AUDITORIUM AVE

W:\Well_Infrastructure\sasko\20164867\04\01\2018-04-12\Final_Draft\100_Civil\4867-00-c-001-301.dwg
DATE: 2018-05-16, Chris Duncan

AE PROJECT No.	20164867
SCALE	AS SHOWN
APPROVED	K. STURGEON
DATE	2018MAY16
REV	A
DESCRIPTION	FINAL

CROSS SECTION
CITY OF SASKATOON
HOK, INC

FOR PLANNING ONLY
NOT FOR CONSTRUCTION

TRANSPORTATION
IDYLVYLD DRIVE
RECOMMENDED PLAN

DWG No. 4867-00-C-301

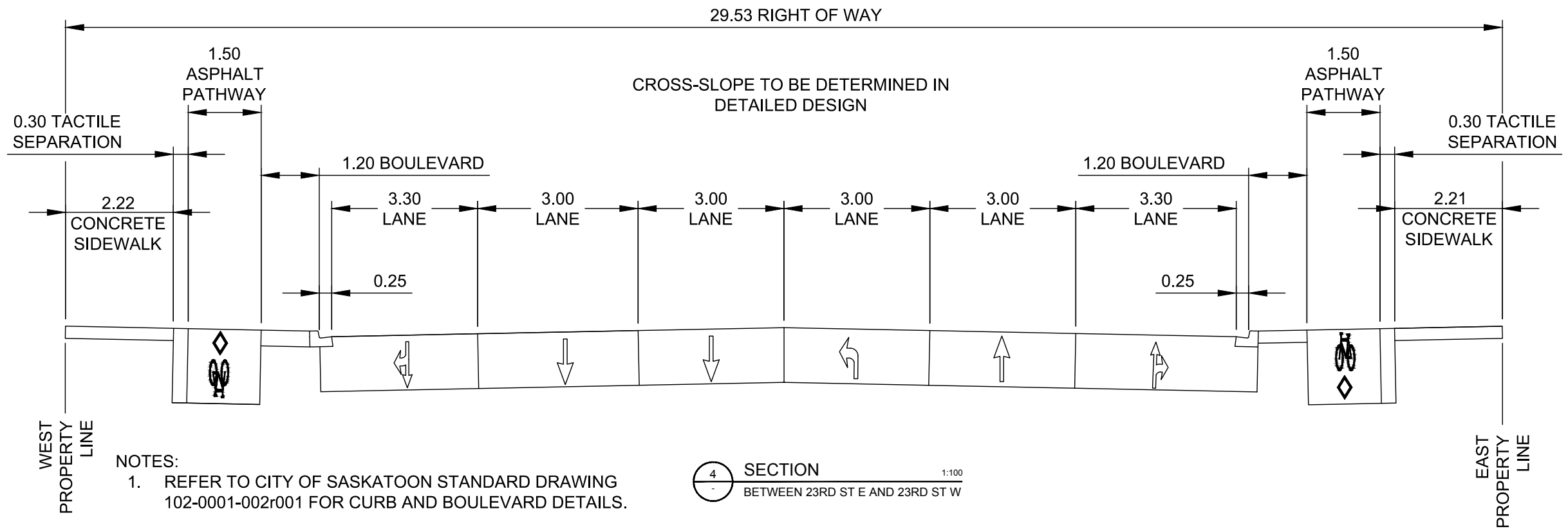
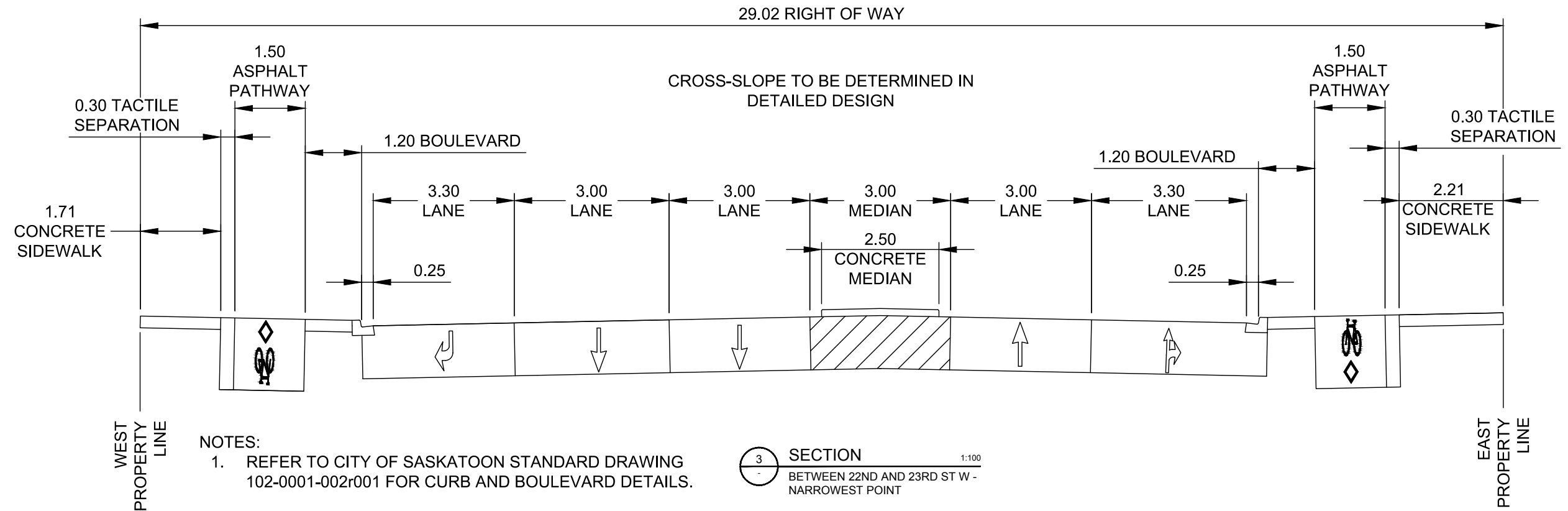

W:\Well_Infrastructure\sask20164867\idylwyld\2018-04-12\Final_Draft\100_Civil\4867-00-c-001-301.dwg
DATE: 2018-05-16, Chris Duncan

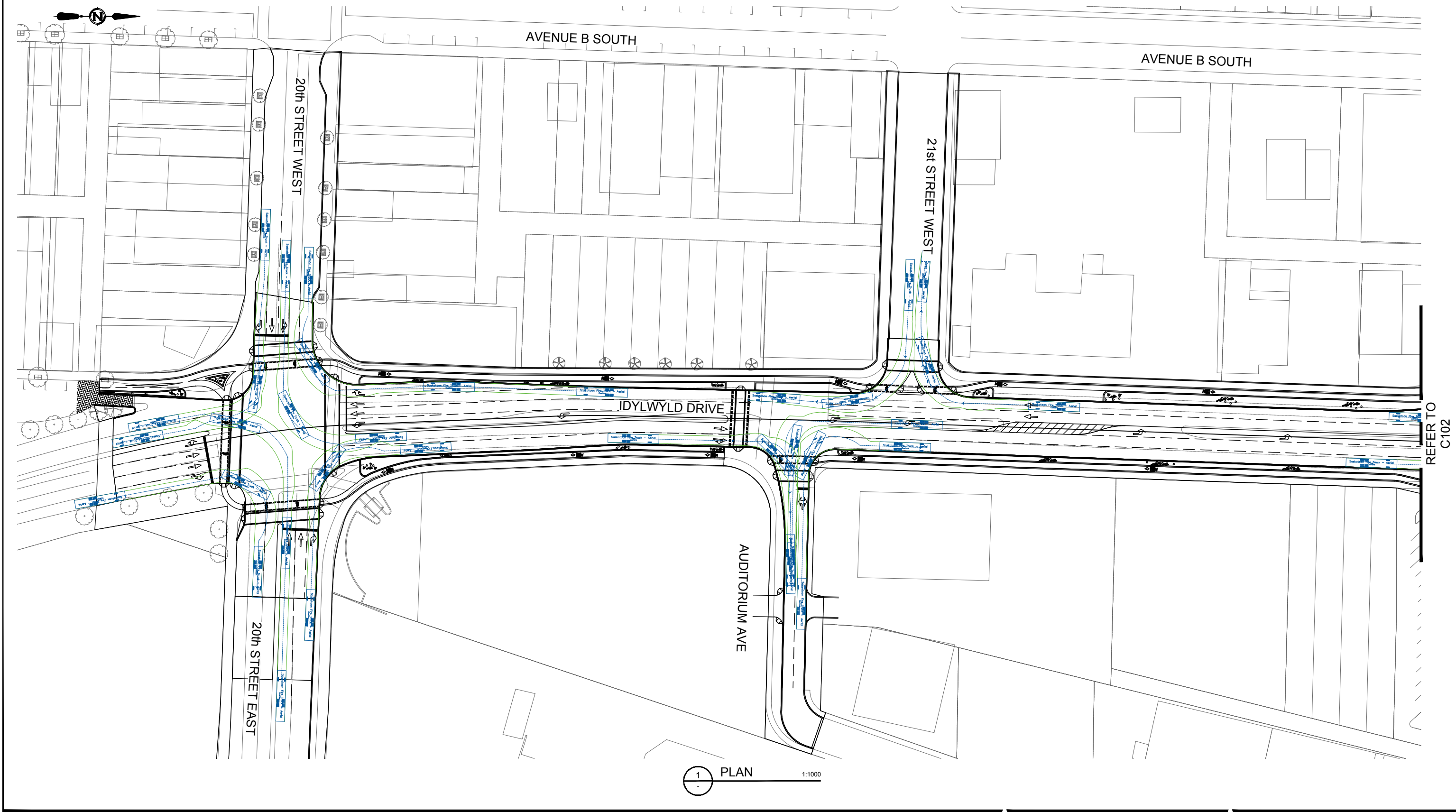

REFER TO
C102

1 PLAN 1:1000

W:\vel_infrastructure\task\20164867-16\dwg\2018-04-12-Final_Draft\100_Civil\4867-00-c-701-703.dwg
DATE: 2018-05-16, Chris Duncan



AE PROJECT No.	20164867
SCALE	AS SHOWN
APPROVED	K. STURGEON
DATE	2018MAY16
REV	A
DESCRIPTION	FINAL

TURNING MOVEMENTS - FIRETRUCK
CITY OF SASKATOON
HOK, INC

FOR PLANNING ONLY
NOT FOR CONSTRUCTION

TRANSPORTATION
IDYLWYLD DRIVE
RECOMMENDED PLAN

DWG No. 4867-00-C-701

AVENUE B NORTH

AVENUE B NORTH

22nd STREET WEST

23rd STREET WEST

JAMIESON STREET

IDYLWYLD DRIVE

WALL STREET

22nd STREET EAST

23rd STREET EAST

REFER TO
C101

REFER TO
C103

2 PLAN 1:1000

W:\a\infrastructure\sask20164867\idylwyld\2018-04-12\Final_Draft\100_Civil\4867-00-c-701-703.dwg
DATE: 2018-05-16, Chris Duncan



AE PROJECT No.	20164867
SCALE	AS SHOWN
APPROVED	K. STURGEON
DATE	2018MAY16
REV	A
DESCRIPTION	FINAL

TURNING MOVEMENTS - FIRETRUCK
CITY OF SASKATOON
HOK, INC

TRANSPORTATION
IDYLWYLD DRIVE
RECOMMENDED PLAN

FOR PLANNING ONLY
NOT FOR CONSTRUCTION

DWG No. 4867-00-C-702

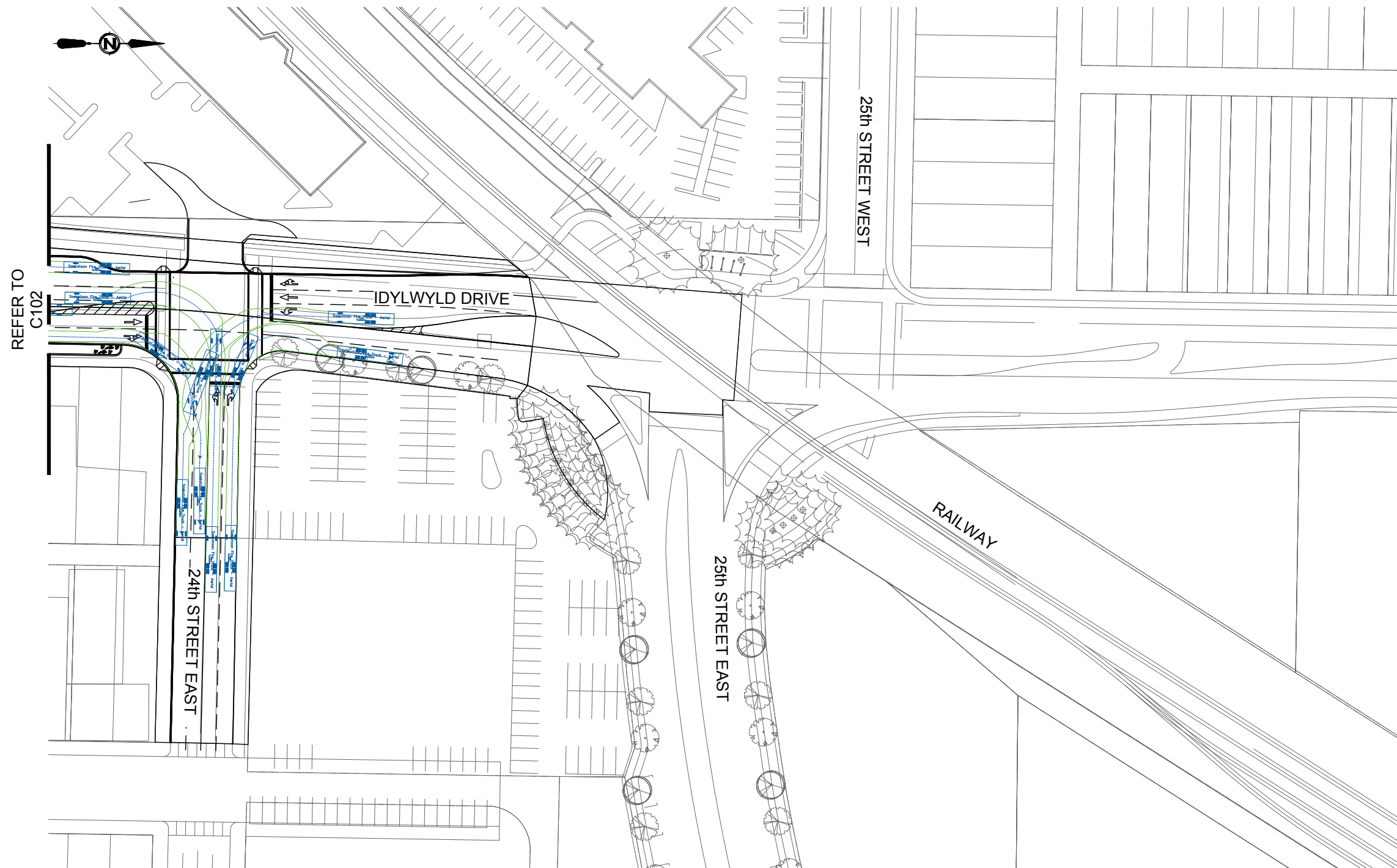

3 PLAN 1:1000

W:\a\Infrastructure\sasko\20164867\2018-04-12\Final_Draft\100_Civil\4867-00-c-701-703.dwg
DATE: 2018-05-16, Chris Duncan



AE PROJECT No.	20164867
SCALE	AS SHOWN
APPROVED	K. STURGEON
DATE	2018MAY16
REV	A
DESCRIPTION	FINAL

TURNING MOVEMENTS - FIRETRUCK
CITY OF SASKATOON
HOK, INC

FOR PLANNING ONLY
NOT FOR CONSTRUCTION

TRANSPORTATION
IDYLWYLD DRIVE
RECOMMENDED PLAN

DWG No. 4867-00-C-703

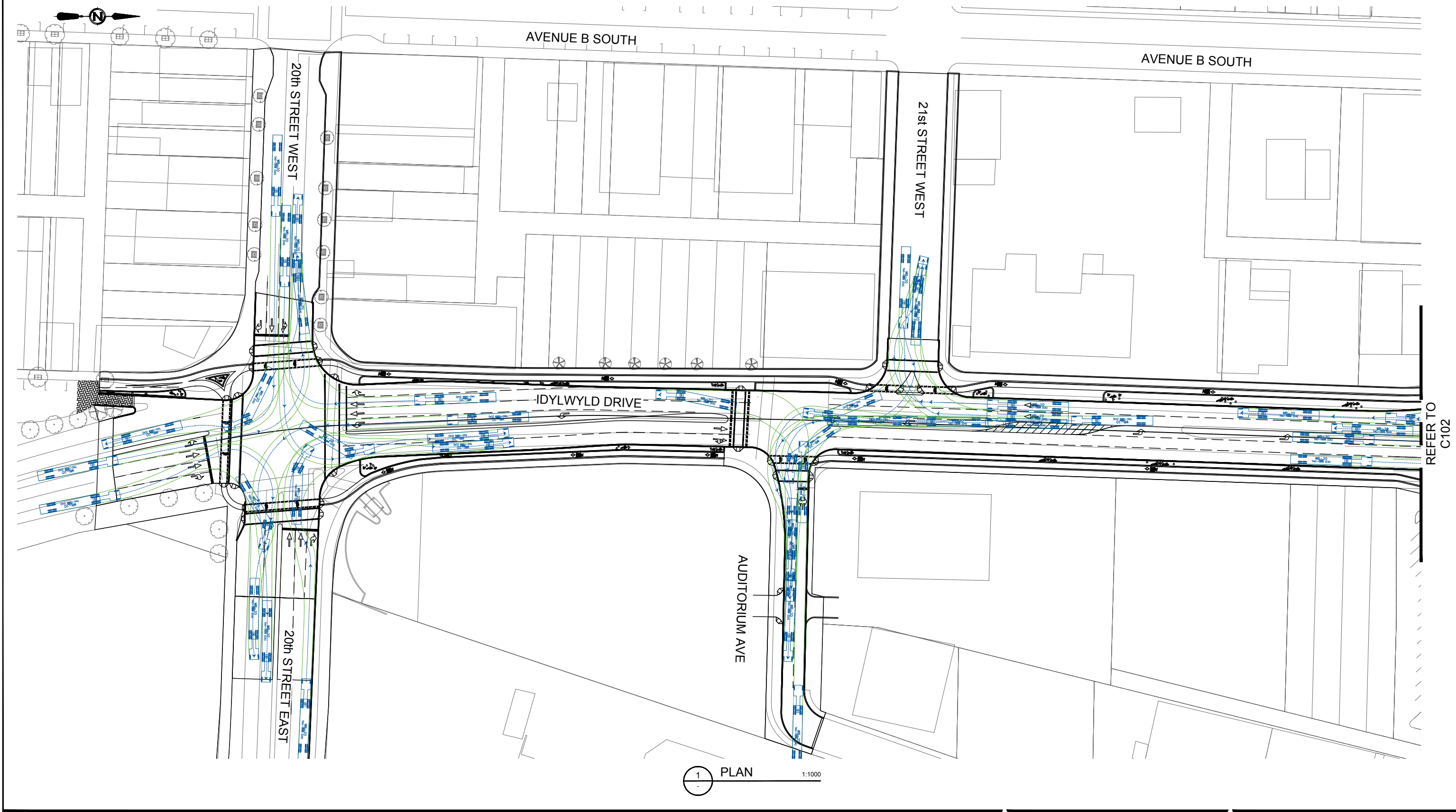

REFER TO
C102

1 PLAN 1:1000

W:\vel_infrastructure\as20164867-16\w\dwg\2018-04-12-Final_Draft\100_Civil\4867-00-c-704-706.dwg
DATE: 2018-05-16, Chris Durcan



AE PROJECT No.	20164867
SCALE	AS SHOWN
APPROVED	K. STURGEON
DATE	2018MAY16
REV	A
DESCRIPTION	FINAL

TURNING MOVEMENTS - WB-20	
CITY OF SASKATOON HOK, INC	
TRANSPORTATION IDYLWYLD DRIVE RECOMMENDED PLAN	
DWG No.	4867-00-C-704

FOR PLANNING ONLY
NOT FOR CONSTRUCTION

AVENUE B NORTH

AVENUE B NORTH

22nd STREET WEST

23rd STREET WEST

JAMIESON STREET

IDYLWYLD DRIVE

WALL STREET

22nd STREET EAST

23rd STREET EAST

REFER TO
C101

REFER TO
C103

2 PLAN 1:1000

W:\a\infrastructure\sask20164867\idylwyld\2018-04-12\Final_Draft\100_Civil\4867-00-c-704-705.dwg
DATE: 2018-05-16, Chris Duncan



AE PROJECT No.	20164867
SCALE	AS SHOWN
APPROVED	K. STURGEON
DATE	2018MAY16
REV	A
DESCRIPTION	FINAL

TURNING MOVEMENTS - WB-20	
CITY OF SASKATOON HOK, INC	
TRANSPORTATION IDYLWYLD DRIVE RECOMMENDED PLAN	
DWG No.	4867-00-C-705

FOR PLANNING ONLY
NOT FOR CONSTRUCTION

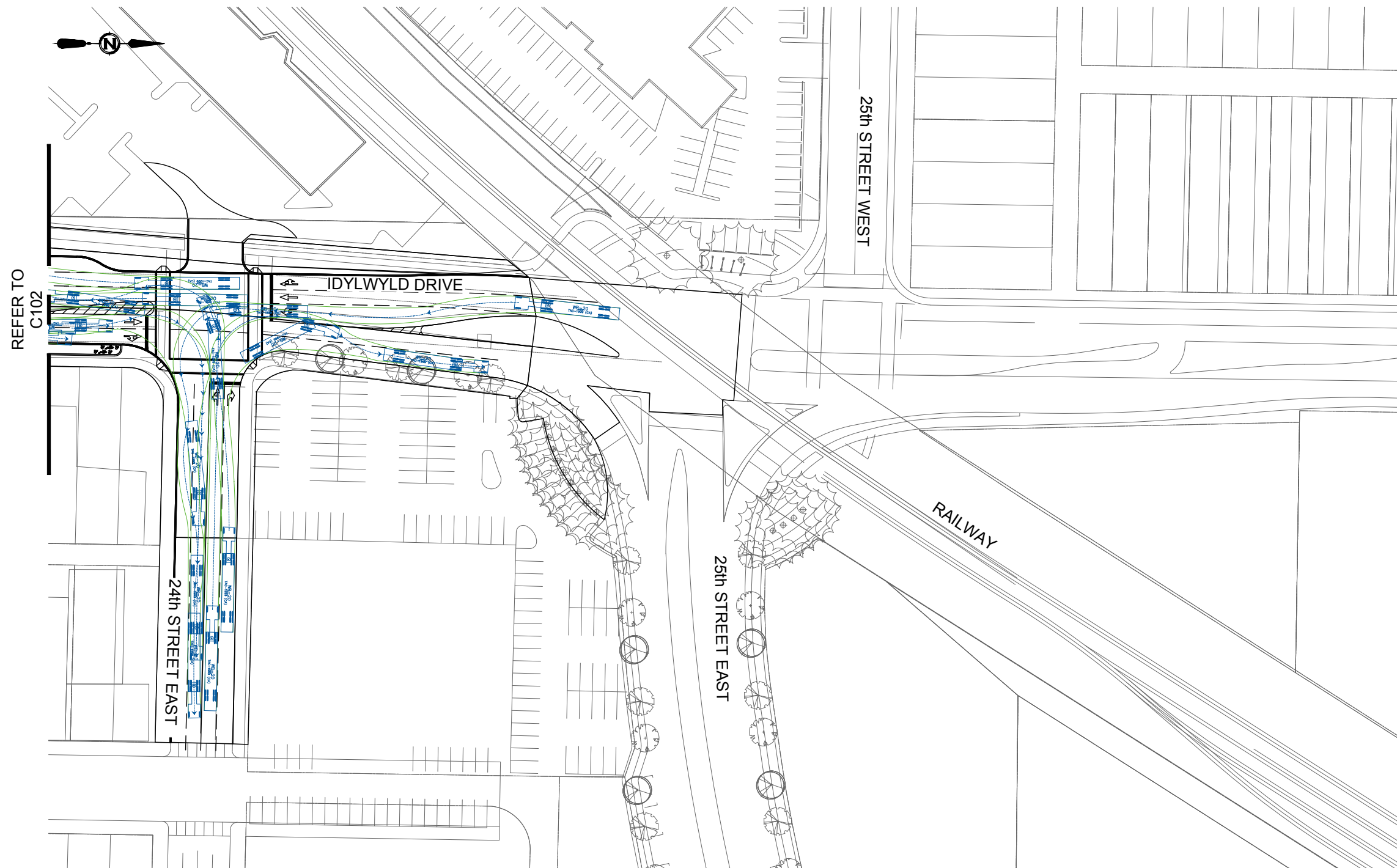

3 PLAN 1:1000

W:\a\Infrastructure\sasko\20164867\idylwyld\2018-04-12\Final_Draft\100_Civil\4867-00-c-704-706.dwg
DATE: 2018-05-16, Chris Duncan



AE PROJECT No.	20164867
SCALE	AS SHOWN
APPROVED	K. STURGEON
DATE	2018MAY16
REV	A
DESCRIPTION	FINAL

TURNING MOVEMENTS - WB-20

CITY OF SASKATOON
HOK, INC

FOR PLANNING ONLY
NOT FOR CONSTRUCTION

TRANSPORTATION
IDYLWYLD DRIVE
RECOMMENDED PLAN

DWG No. 4867-00-C-706

REPORT



Appendix B – Current Conditions and Improvement Options Report, March 2017

TECHNICAL APPENDIX

Imagine Idylwyld



Transportation and Connectivity Current Conditions and Improvement Options

March 2017

CONFIDENTIALITY AND © COPYRIGHT

This document is for the sole use of the addressee and Associated Engineering (Sask.) Ltd. The document contains proprietary and confidential information that shall not be reproduced in any manner or disclosed to or discussed with any other parties without the express written permission of Associated Engineering (Sask.) Ltd. Information in this document is to be considered the intellectual property of Associated Engineering (Sask.) Ltd. in accordance with Canadian copyright law.

This report was prepared by Associated Engineering (Sask.) Ltd. for the account of HOK, Inc. The material in it reflects Associated Engineering (Sask.) Ltd.'s best judgement, in the light of the information available to it, at the time of preparation. Any use which a third party makes of this report, or any reliance on or decisions to be made based on it, are the responsibility of such third parties. Associated Engineering (Sask.) Ltd. accepts no responsibility for damages, if any, suffered by any third party as a result of decisions made or actions based on this report.

Table of Contents

SECTION	PAGE NO.
Table of Contents	i
List of Tables	ii
List of Figures	iii
1 Current Conditions	1
1.1 Conditions for Drivers	1
1.2 Conditions for People Walking	13
1.3 Conditions for People Riding Bicycles	17
1.4 Conditions for People Using Transit	18
1.5 Conditions for Freight Trucks	18
2 Improvement Options	20
2.1 Engineering Standards of Care	20
2.2 Technical Reference Publications	20
2.3 Measures of Effectiveness	21
2.4 Geometric Design Parameters	23
2.5 Traffic Signal Timing Parameters	26
2.6 Initial Concept Layout	28
2.7 Other Concepts for Evaluation	32
References	
Certification Page	
Appendix A - Microsimulation Analysis – Current Layout	
Appendix B - HCM 2010 Analysis – Current Layout	
Appendix C - Initial Concept Layout	
Appendix D - HCM 2010 Analysis – Initial Concept Layout	

List of Tables

	PAGE NO.	
Table 1-1	Study Intersections	1
Table 1-2	Current Traffic Conditions, Morning Peak Hour	6
Table 1-3	Current Traffic Conditions, Afternoon Peak Hour	6
Table 1-4	Forecast Traffic Conditions, Morning Peak Hour at 400,000 Population	7
Table 1-5	Forecast Traffic Conditions, Afternoon Peak Hour at 400,000 Population	7
Table 1-6	Simulated Corridor Travel Times, Afternoon Peak Hour	8
Table 1-7	Crash History Summary	13
Table 1-8	Implied Walking Speed	14
Table 2-1	Measures of Effectiveness	22
Table 2-2	Lane Width Design Parameters	24
Table 2-3	Curb Radius	25
Table 2-4	Sidewalk Design Parameters	26
Table 2-5	Traffic Signal Timing Parameters	28
Table 2-6	Initial Concept Traffic Conditions, Morning Peak Hour	31
Table 2-7	Initial Concept Traffic Conditions, Afternoon Peak Hour	31
Table 2-8	Initial Concept Traffic Conditions, Morning Peak Hour, 400,000 Population	32
Table 2-9	Initial Concept Traffic Conditions, Afternoon Peak Hour, 400,000 Population	32

List of Figures

	PAGE NO.	
Figure 1-1	Current Traffic Volumes, Morning Peak Hour	2
Figure 1-2	Current Traffic Volumes, Afternoon Peak Hour	3
Figure 1-3	Forecast Traffic Volumes, Morning Peak Hour at 400,000 Population	3
Figure 1-4	Forecast Traffic Conditions, Afternoon Peak Hour at 400,000 Population	4
Figure 1-5	North Leg of Idylwyld at 20 th Street, Facing North	9
Figure 1-6	North Leg of Idylwyld at Auditorium Avenue, Facing North	9
Figure 1-7	South Leg of Idylwyld at 22 nd Street, Facing North	9
Figure 1-8	North Leg of Idylwyld at 22 nd Street, Facing North	10
Figure 1-9	North Leg of Idylwyld at 24 th Street, Facing North	10
Figure 1-10	Access to Avenue A South	11
Figure 1-11	Northeast Corner of 20 th Street Intersection	15
Figure 1-12	Auditorium Avenue Sidewalk	17
Figure 1-13	TCU Place and Midtown Plaza Loading Docks	19
Figure 2-1	Base Concept Cross Section – Midblock	29
Figure 2-2	Base Concept Cross Section – Intersections	29
Figure 2-3	Conceptual Cross Section with Auxiliary Right Turn Lane	30
Figure 2-4	Initial Concept Layout	30

1 Current Conditions

Current conditions were assessed based on a combination of field observations, data provided by the City of Saskatoon, and analysis as described in this section.

1.1 CONDITIONS FOR DRIVERS

1.1.1 Capacity Analysis – Methods and Inputs

The Idylwyld study corridor includes nine intersections. Their control types are summarized in Table 1-1.

**Table 1-1
Study Intersections**

Cross Street	Control	Notes
20th Street	Signal	
Auditorium Ave	Stop + Pedestrian Half-Signal	
21st Street W	Stop	Right-In, Right-Out Only
22nd Street	Signal	
23rd Street W	Stop	Right-In, Right-Out Only
23rd Street E / Jamieson Street	Signal	
24th Street E	Signal	
25th Street E	Signal	
25th Street W	Stop	Right-In, Right-Out Only

Two methods were used for traffic engineering analysis of the Idylwyld study area corridor:

- Highway Capacity Manual
- Microsimulation

The Highway Capacity Manual, 2010 (HCM 2010) provides a deterministic method to calculate intersection performance, while microsimulation is more appropriate for analysis of the study area corridor as a whole. PTV Vistro software is used for HCM 2010 analysis, while PTV Vissim software is used for microsimulation. Details on microsimulation analysis are found in Appendix A.

Imagine Idylwyld

The following outlines traffic engineering assumptions used within the HCM 2010 analysis. Full analysis reports for current conditions are found in Appendix B.

The analysis focusses on the signalized intersections, including Auditorium Avenue. The HCM 2010 does not include analysis methods for half-signalized intersections, therefore Auditorium Avenue is assumed to operate as a fully-signalized intersection. The stop controlled intersections permit right turns only, and are low-volume local streets. They have been omitted from the following discussion for simplicity, although analysis reports are included in Appendix B.

1.1.1.1 Traffic Volumes

Traffic volumes were provided by the City for morning and afternoon peak periods for both current traffic conditions and traffic conditions forecast to a 400,000 population horizon. Current traffic volumes for each movement are shown in Figure 1-1 and Figure 1-2 for the morning and afternoon peak hours, respectively; traffic volumes forecast to a city population of 400,000 are shown in Figure 1-3 and Figure 1-4.

**Figure 1-1
Current Traffic Volumes, Morning Peak Hour**

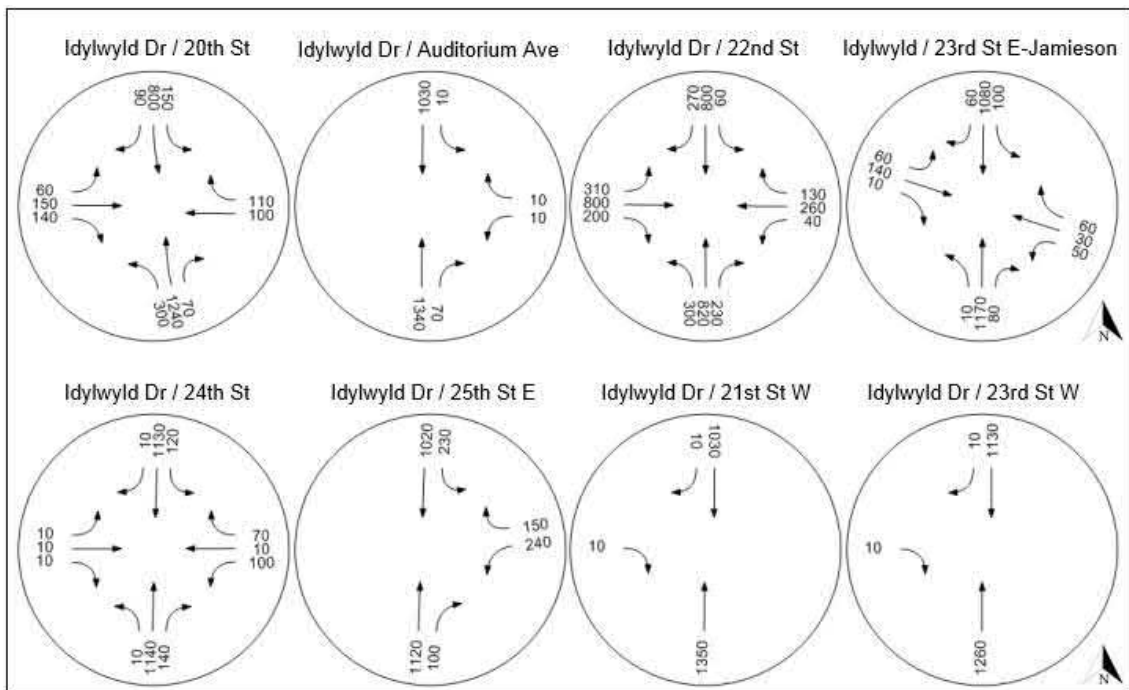

Figure 1-2
 Current Traffic Volumes, Afternoon Peak Hour

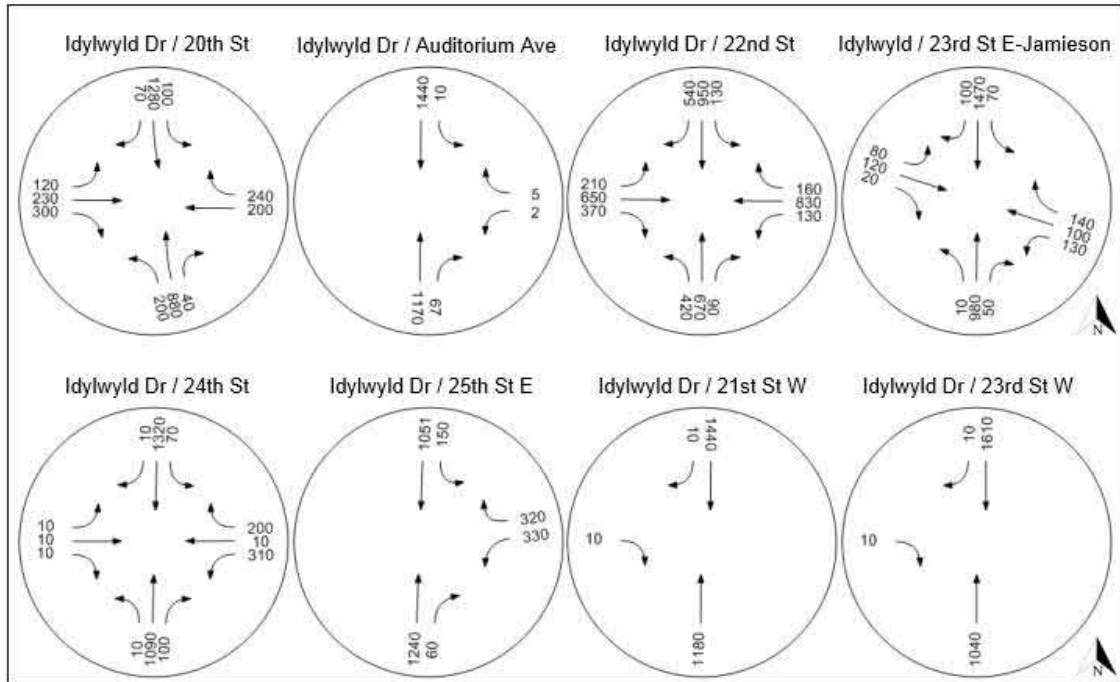

Figure 1-3
 Forecast Traffic Volumes, Morning Peak Hour at 400,000 Population

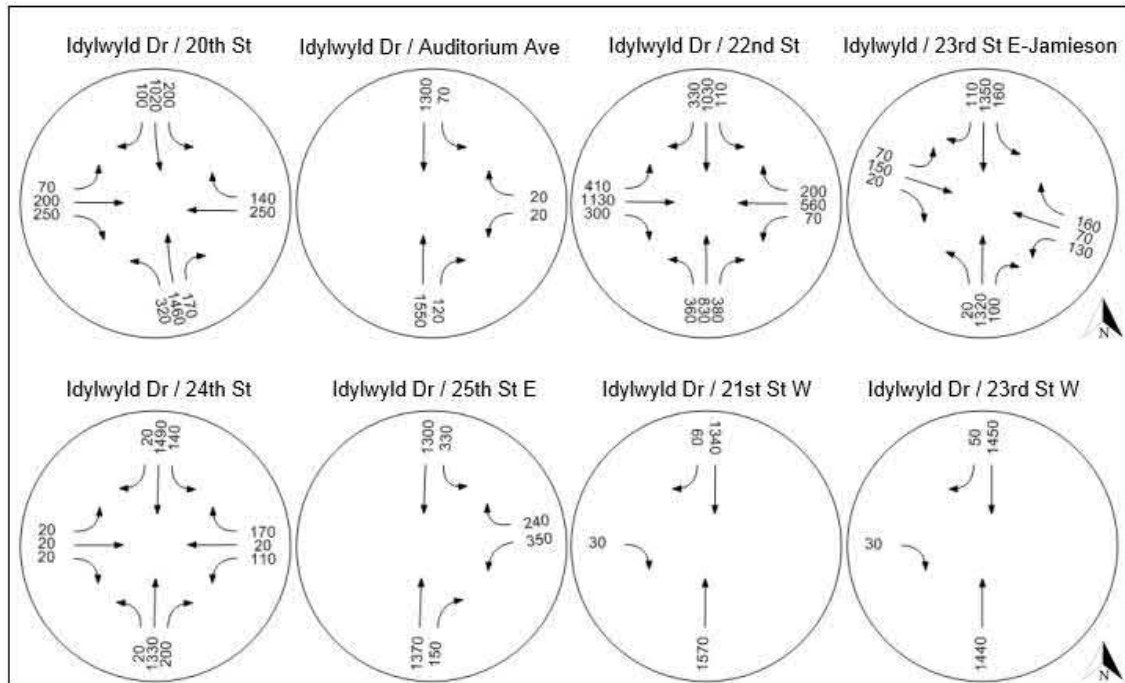
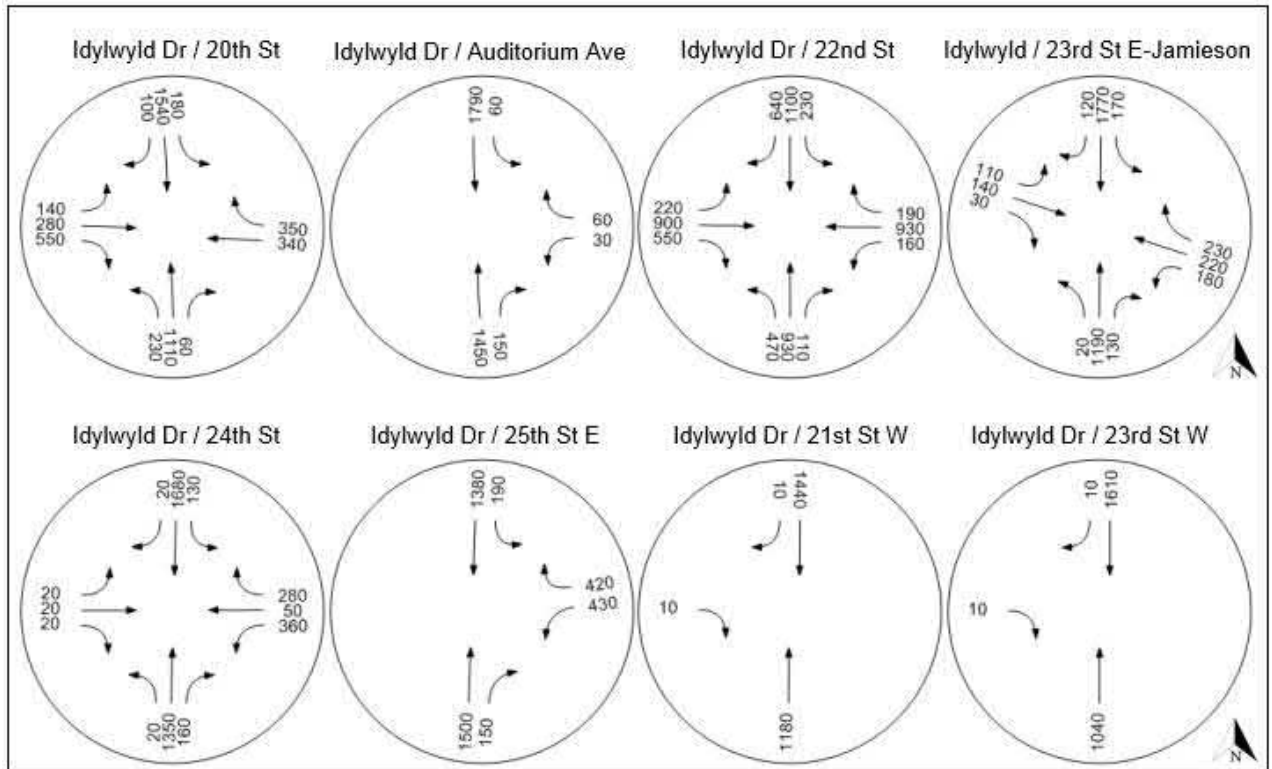

Figure 1-4
Forecast Traffic Conditions, Afternoon Peak Hour at 400,000 Population



1.1.1.2 Peak Hour Factor

A peak hour factor is used when analysis of the busiest 15 minutes within the peak hour is desired. A peak hour factor of 1.0 is used for this study as suggested by the City of Saskatoon, indicating that analysis is conducted for the peak hour overall, and not the peak 15 minutes.

1.1.1.3 Lane Utilization Adjustment Factor

The Lane Utilization Adjustment Factor is used to account for imbalanced lane usage. Values less than 1.0 indicate that traffic is not uniformly distributed among lanes with identical configurations. Default HCM 2010 Lane Utilization Adjustment factors were used at all locations with the exception of the southbound approach to 22nd Street.

The Lane Utilization Adjustment Factor can only be overridden from its default value where two or more lanes have the same configuration. As such, alternate values cannot be used, for example, at the northbound approach to 22nd Street, which has four lanes but none with identical configuration (the configurations are left only, through/left, through only, through/right).

The southbound approach to 22nd Street was observed to have significantly uneven traffic distribution between the two exclusive through lanes. This is a result of drivers predominantly selecting the leftmost of the two lanes well in advance of the 20th Street intersection, where only this lane continues southbound to the bridge, while the other would force a right turn onto 20th Street.

Calculating an adjustment factor requires the ratio of traffic volumes in each lane. Lane volumes were not available. Rather, for the southbound approach to 22nd Street, queue lengths were observed in the field and the ratio of queue lengths in each lane during the PM peak period was used as a proxy measure for the traffic volume ratio.

Queues were observed to be more than twice as long in the leftmost through lane than the rightmost through lane, generally exceeding 200 m in the former and less than 100 m in the latter. The ratio 2:1 was assumed. According to HCM 2010 Equation 18-4, this results in a factor of 0.75, which was used for the current conditions analysis.

For future conditions, all design alternatives will include lane continuity through the corridor. Accordingly, the Lane Utilization Adjustment Factor will be returned to its default value.

1.1.1.4 Right Turn on Red Volume

The HCM 2010 does not include a method to estimate right turn on red volume. Rather, the HCM requires manual count of right turn on red traffic in the field. In the absence of such data, the HCM suggests assuming zero right turns on red to produce a conservative estimate of the levels of service. The HCM also suggests that if a dedicated right turn lane is available along with a shadowing protected left turn phase, the right turn volume can be reduced by an amount equivalent to the shadowing left turn volume (p. 18-10).

A shadowing protected left turn phase is the phase where no permitted vehicular or pedestrian movement would conflict with the subject right turn. For example, an eastbound left turn shadows a southbound right turn.

Right turn on red volumes are not available. Accordingly, right turn on red volumes were assumed to be zero, except where a dedicated right turn lane is available and the shadowing left turn has a protective phase. To estimate the capacity gained in this manner, the right turn was encoded as having a green signal overlapping the shadowing protected left turn signal phase.

An overlapping phase operation was not assumed for the westbound right turn from 23rd Street East since that right turn bay is quite short and shared with a through bike lane. It is unlikely to operate as a free-flow right turn during the southbound left turn phase.

1.1.2 Analysis Results

Table 1-2 and Table 1-3 summarize current traffic conditions in each peak hour for each signalized intersection. Measures include the volume to capacity ratio, average intersection delay, and level of service. Detailed analysis results including individual lane group results are provided in Appendix B.

**Table 1-2
Current Traffic Conditions, Morning Peak Hour**

Cross Street	Volume / Capacity	Average Delay	Level of Service
20th Street	0.51	17 s	B
Auditorium Avenue	0.34	3 s	A
22nd Street	0.83	68 s	E
23rd Street East / Jamieson Street	0.52	15 s	B
24th Street East	0.65	13 s	B
25th Street East	0.61	16 s	B

**Table 1-3
Current Traffic Conditions, Afternoon Peak Hour**

Cross Street	Volume / Capacity	Average Delay	Level of Service
20th Street	0.76	28 s	C
Auditorium Avenue	0.36	1 s	A
22nd Street	1.02	73 s	F*
23rd Street East / Jamieson Street	0.60	18 s	B
24th Street East	0.89	28 s	C
25th Street East	0.74	25 s	C

*Level of service is defined as F when volume exceeds capacity regardless of average delay.

Table 1-4 and Table 1-5 summarize the traffic conditions using traffic volumes forecast for a city population of 400,000. These results assume the same geometry and traffic signal timing as currently exist.

**Table 1-4
Forecast Traffic Conditions, Morning Peak Hour at 400,000 Population**

Cross Street	Volume / Capacity	Average Delay	Level of Service
20th Street	0.79	24 s	C
Auditorium Avenue	0.42	6 s	A
22nd Street	1.10	128 s	F
23rd Street East / Jamieson Street	0.82	22 s	C
24th Street East	0.82	23 s	C
25th Street East	0.86	28 s	C

**Table 1-5
Forecast Traffic Conditions, Afternoon Peak Hour at 400,000 Population**

Cross Street	Volume / Capacity	Average Delay	Level of Service
20th Street	1.06	40 s	F*
Auditorium Avenue	0.50	9 s	A
22nd Street	1.33	135 s	F*
23rd Street East / Jamieson Street	1.10	34 s	C
24th Street East	1.22	65 s	F*
25th Street East	0.68	38 s	D

*Level of service is defined as F when volume exceeds capacity regardless of average delay.

1.1.2.1 Railway Crossing Impacts to Traffic Flow

The Canadian Pacific Railway crosses Idylwyld Drive at the intersection of 25th Street East. A crossing train can have a significant effect on traffic operations lasting for several minutes after it clears. However, railway crossing impacts are excluded from the scope of this study as directed by the City of Saskatoon. It is understood that a separate study will examine railway impacts from a broader, city-wide perspective and include an evaluation of various options for addressing railway impacts.

1.1.3 Microsimulation Results

A full microsimulation was completed for the afternoon peak period with current traffic conditions. Travel times are one key output of the model. Selected corridor travel times are summarized in Table 1-6. Details on the microsimulation procedures and results can be found in Appendix A. Corridor

**Table 1-6
Simulated Corridor Travel Times, Afternoon Peak Hour**

Travel Segment	Travel Time
Idylwyld Drive Northbound from above 19th Street to 25th Street West	132 s
Idylwyld Drive Southbound from 25th Street West to above 19th Street	136 s
25th Street East at Pacific Avenue to 22nd Street at Avenue B	140 s
22nd Street at Avenue B to 25th Street at Pacific Avenue	143 s
Idylwyld Drive above 19th Street to 22nd Street at Avenue B	74 s
22nd Street at Avenue B to Idylwyld Drive above 19th Street	98 s

1.1.4 Lane Alignment and Continuity

North of the study corridor, from the start of the 50 km/h zone at 39th Street to 25th Street, Idylwyld Drive has a consistent lane designation: four basic lanes and a median with alternating left turn bays at intersections where left turns are permitted. Through the study corridor, the number of lanes and their function changes with nearly each block.

Heading southbound, a driver continuing in the right hand lane through the city would end up in a right-turn only lane approaching 20th Street. Only the left lane continues through the corridor, becoming the right hand lane south of 20th Street. A third lane is added to the left at 24th Street, but it acts as a shared left turn and through lane at 24th Street, 23rd Street, and 22nd Street, and at Auditorium Avenue, there is a narrow, unstriped turn bay where a left turning vehicle may impede the driving lane, depending on the vehicle size and positioning within the lane. A fourth southbound lane exists from Jamieson Street to 22nd Street, where it becomes a right turn lane.

Heading northbound from the Senator Sid Buckwold Bridge and after the diverge exit to 1st Avenue, there are two driving lanes. Just before 20th Street, a third lane is added to the right and a left turn bay tapers out to the left. The added right hand lane continues until 24th Street, where it becomes a right turn lane. In this direction there is lane continuity, in that the two lanes entering the corridor both depart the corridor. However, there is no dedicated left turn lane at 23rd Street or 24th Street, therefore the left hand lane is impeded by left turning vehicles. At the approach to 22nd Street, there are two left turn lanes, of which only one is in a turn bay while the other is shared with through traffic.

1.1.5 Cross Sections

Figures 2-1 through 2-5 represent the cross section at several representative locations along the study corridor. In all cases, cross sections are taken as a viewer facing north and are schematic only (Images: StreetMix).

Figure 1-5
North Leg of Idylwyld at 20th Street, Facing North

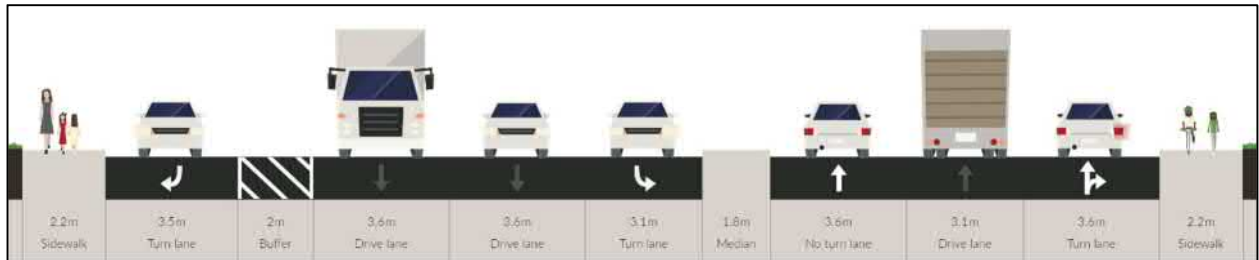

Figure 1-6
North Leg of Idylwyld at Auditorium Avenue, Facing North

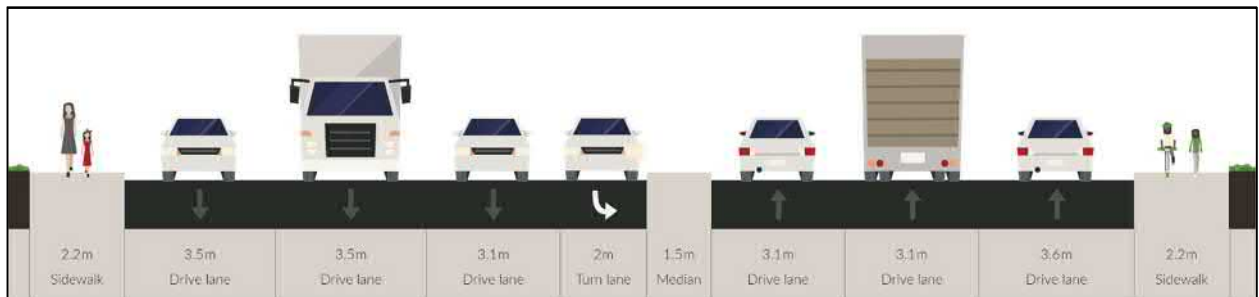

Figure 1-7
South Leg of Idylwyld at 22nd Street, Facing North

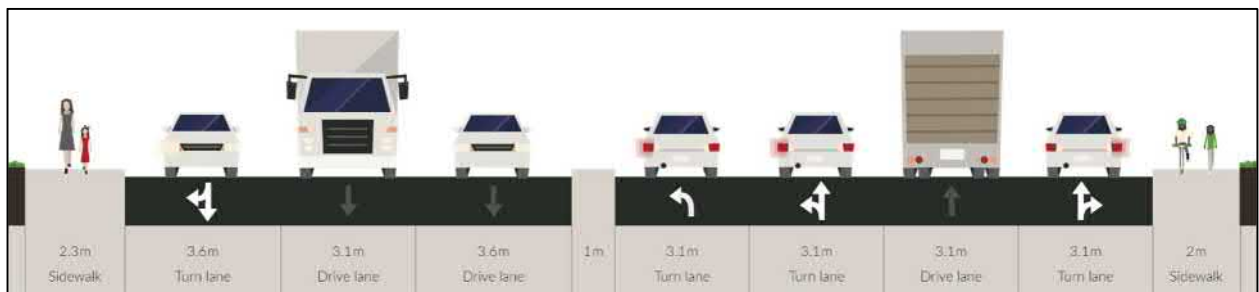

Figure 1-8
North Leg of Idylwyld at 22nd Street, Facing North

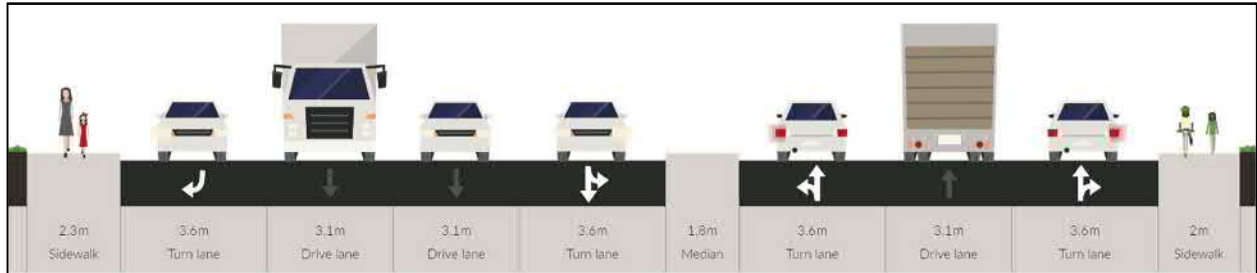
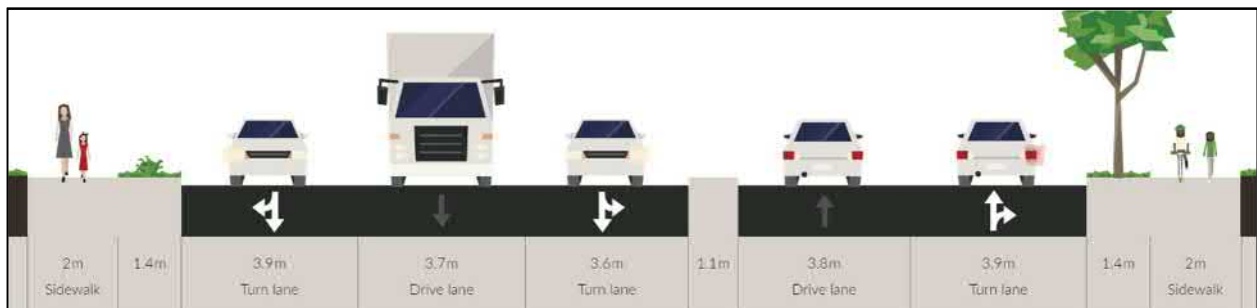

Figure 1-9
North Leg of Idylwyld at 24th Street, Facing North



1.1.6 Avenue A South

Avenue A is an unusual access type, with only southbound access from Idylwyld Drive, effectively an off-ramp-style access. Northbound traffic on Avenue A cannot access Idylwyld Drive and instead must turn left into an alley. Figure 1-10 illustrates the Avenue A access and surrounding area.

Potential conflicts exist around the alley intersection with Avenue A. Drivers heading south and following the right hand curb would be pointing toward the parking lane that begins just after the alley. A quick correction to the left would be required to avoid colliding with a parked car.

For northbound drivers, landscaping treatments including shrubs give the appearance of limited sight distance. Since these drivers are forced to turn left, they may focus too strongly on the direction of oncoming traffic, diverting attention away from the other potential conflicts, including with a pedestrian on the sidewalk, or navigating the tight space available if there is an eastbound vehicle in the alley.

For eastbound drivers in the alley, the sight lines to observe pedestrians on the sidewalk or vehicles coming from the north are constrained by building corners that extend to the limits of the alley right of way.

Figure 1-10
Access to Avenue A South

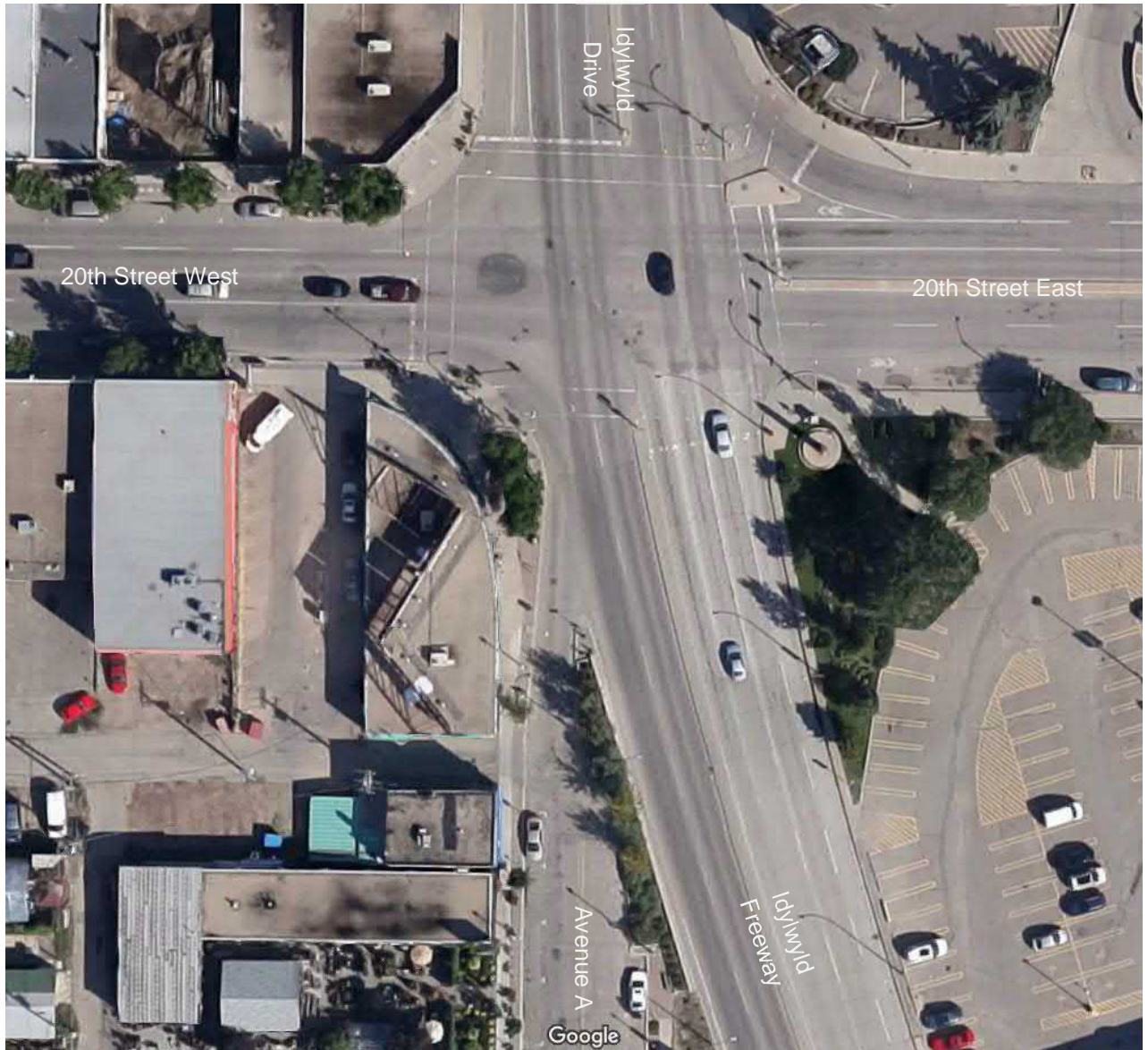

1.1.7 Turn Restrictions

The westbound left turn from 20th Street to Idylwyld Freeway is currently prohibited, since the same movement can be accomplished using the 1st Avenue South freeway on-ramp one block to the east.

There would be very minimal benefit to permitting this movement, while the risk would be less efficient traffic signal timing and increased congestion at the intersection, additional space requirements for a left

turn lane, additional crossing distance and risk exposure for pedestrians and cyclists, and a risk that drivers would attempt to turn left directly onto Avenue A.

The intersections of 21st Street West, 23rd Street West and 25th Street West are tee-intersections on the west side of Idylwyld Drive and are limited to right turns only: northbound and eastbound left turns are prohibited. Opening these intersections to additional movements would also require an assessment of the need for traffic signals, however, each intersection is within 100 m of a signalized intersection. Adding new closely spaced signals is undesirable due to issues of coordination and queuing.

1.1.8 Channelized Right Turns

Channelized right-turn lanes are present throughout the study area. These channelized lanes are designed to increase the turning radius and speed of right turning traffic and allow yielding rather than a full stop before entering to the traffic flow of the receiving street. As noted in the NACTO *Urban Streets Design Guide* (p.94), channelized right turn lanes create unsafe, high-speed turns where the driver of the vehicle is focused on incoming traffic through the intersection rather than pedestrian traffic.

The intersections at 22nd Street and 25th Street East have channelized right-turns on each leg of the intersection. Channelized right turns are also present for the westbound right turn from 20th Street and the southbound right turn to Jamieson Street.

1.1.9 Driveways

There are also around 19 driveways with access directly onto Idylwyld Drive. Driveways can create a safety risk for drivers and pedestrians and delay for drivers as a vehicle slows to make a turn. The fire hall has a particularly wide driveway with a special traffic signal used only when Fire Department vehicles are present. No particular major safety concerns regarding the driveways have been identified requiring immediate changes. Over the long term, access could evolve to other means, such as rear-lane access as land use changes.

1.1.10 Crash History

The crash history data available mostly pre-dates the opening of the Circle Drive South and 25th Street extensions. The intersections of 20th Street, 22nd Street, and 24th Street comprised over two-thirds (67%) of all crashes between 2010 and 2013. Table 1-7 identifies the three most common crash types for the three intersections.

**Table 1-7
Crash History Summary**

Intersection	Type of Crash	Number of Crashes (2010 – 2013)	Percentage of Total Crashes at Intersection
20th Street	Rear End	116	50%
	Left-turn/Straight – Opposite Direction	35	15%
	Side Swipe – Same Direction	27	12%
22nd Street	Rear End	164	44%
	Left-turn/Straight – Opposite Direction	49	13%
	Side Swipe – Same Direction	56	15%
24th Street E	Rear End	39	32%
	Left-turn/Straight – Opposite Direction	24	20%
	Side Swipe – Same Direction	15	13%

Details on the exact location within the intersection and the contributing factors were not available in the data provided. However, circumstances leading to the high number of rear end crashes at 20th Street could be related to the speed change northbound coming from the Idylwyld Freeway to a 50 km/h zone. At 22nd Street and 20th Street, rear end crashes could also be related to right turning traffic stopping to yield to pedestrians at the channelization islands, and the tailing driver anticipating a higher speed turn.

1.2 CONDITIONS FOR PEOPLE WALKING

1.2.1 Pedestrian Clearance Intervals and Assumed Walking Speed

The Canadian Capacity Guide states that pedestrian walking speed is usually 1.2 m/s or 1.0 m/s, although in areas with few pedestrians, 1.5 m/s may be used (p. 3-70). The signal timing along the Idylwyld study area corridor effectively assumes pedestrians can walk faster than that. Table 1-8 summarizes the pedestrian clearance interval, crossing distance, and implied walking speed for each crosswalk. Crossing distances are rounded to the nearest metre. Where channelization islands exist, the crossing distance excludes the crosswalk from the sidewalk to the island.

**Table 1-8
Implied Walking Speed**

Intersection	Intersection Leg	Associated Vehicle Direction	Crossing Distance	Pedestrian Clearance Interval	Implied Walking Speed
20th Street	East	Northbound	20 m	14 s	1.4 m/s
	West	Southbound	20 m	11 s	1.8 m/s
	South	Eastbound	29 m	19 s	1.5 m/s
	North	Westbound	30 m	20 s	1.5 m/s
Auditorium	South	Westbound	26 m	20 s	1.3 m/s
22nd Street	East	Northbound	24 m	15 s	1.6 m/s
	West	Southbound	24 m	16 s	1.5 m/s
	South	Eastbound	23 m	15 s	1.5 m/s
	North	Westbound	23 m	15 s	1.5 m/s
23rd Street E-Jamieson	East	Northbound	27 m	18 s	1.5 m/s
	West	Southbound	18 m	10 s	1.8 m/s
	South	Eastbound	27 m	17 s	1.6 m/s
	North	Westbound	26 m	16 s	1.6 m/s
24th Street E	East	Northbound	15 m	8 s	1.9 m/s
	West	Southbound	12 m	7 s	1.7 m/s*
	South	Eastbound	27 m	17 s	1.6 m/s
	North	Westbound	23 m	13 s	1.8 m/s
25th Street E	East	Northbound	16 m	10 s	1.6 m/s
	North	Westbound	24 m	16 s	1.5 m/s

*Driveway crossing without pedestrian signal head.

1.2.2 Accessibility Ramps

Most intersections have curb cuts for wheelchair ramps. However, some ramps are not in line with the crosswalk, causing confusion.

At 20th Street, three of four corners have curb ramps in appropriate locations. The northeast corner, where there is a channelization island as shown in Figure 1-11 (Image: Google), uses an unusual deflection angle between the main crosswalk and the right turn lane crosswalk which is not parallel with the stop line and violates driver expectation. As well, there is no access from the north-south crosswalk to the channelization island, so a wheelchair user coming from the south, for example, would have to use part of a traffic lane to navigate around the island to reach the other side of the intersection.

Figure 1-11
Northeast Corner of 20th Street Intersection



At Auditorium Avenue and at 21st Street West, curb ramps are present at each end of the designated crosswalks. On the northwest corner of 21st Street West, a catch basin prevents the ramp from being located right at the crosswalk, however, the offset is small and likely not significant.

At 22nd Street, each corner has a channelized right turn. The sidewalk has a curb ramp on each corner, but three of the channelization islands are inaccessible to wheelchairs. The pedestrian actuation button is located on the islands. People in wheelchairs would not be able to call for the walk light, and would have to wait somewhere else, and use parts of the travel lanes to navigate from one side to another. This is a hazardous situation and effectively renders this intersection inaccessible for people with wheelchairs.

At 23rd Street West, only one crosswalk exists on the west leg. Crossing Idylwyld Drive is not accommodated. Curb ramps are present, although offset by about 5 m from the straight line along the sidewalk, and no crosswalk is painted. With low traffic volumes on 23rd Street West, these are not likely major concerns.

At 23rd Street East / Jamieson Street, there are curb ramps on each corner, but the northwest corner of the intersection has a channelization island that is not accessible for people in wheelchairs crossing Idylwyld Drive in the north crosswalk, similar to the west crosswalk at 20th Street.

At 24th Street East, there is a ramp only on the northeast corner. The other corners do not have ramps, although they do have driveways nearby that can be used, but a wheelchair user would have to ride along the traffic lane for a short distance.

The adjacent intersections of 25th Street East and 25th Street West are fully accessible.

1.2.3 Sidewalk Width

The sidewalks along Idylwyld Drive south of 24th Street are narrow, ranging from 1.8 to 2.3 metres, but lampposts, signposts and other obstructions render them effectively much narrower. The block of Idylwyld Drive from 24th Street to 25th Street, which was recently reconstructed, has sidewalks 3.3 metres wide.

The sidewalk width on Auditorium Avenue is particularly noteworthy, especially at the southwest corner of TCU Place as shown in Figure 1-12. With utility pipes partially obstructing the sidewalk, the clear path width is less than 0.9 m and the sidewalk is inaccessible in a wheelchair.

Figure 1-12
Auditorium Avenue Sidewalk



1.3 CONDITIONS FOR PEOPLE RIDING BICYCLES

Idylwyld Drive does not have dedicated infrastructure for people riding bicycles. Although not prohibited, it is very rare for a person riding a bicycle to choose to ride with traffic on Idylwyld Drive. Cyclists that do use the corridor generally ride illegally on the sidewalk.

A parallel cycling-friendly street is available two blocks to the west at Avenue C, however no parallel route is available nearby to the east, and access to properties on Idylwyld Drive itself is also not available without riding in mixed traffic or on the sidewalk.

Crossing Idylwyld Drive is challenging. Most intersections are not equipped to detect bicycles, so signals would not turn green if no cars or pedestrians were present, for example at low volume intersections or late at night. No intersections have infrastructure for bicycles, including the designated cycling corridor at 23rd Street, where the protected bike lanes end just ahead of the Idylwyld Drive intersection.

At 20th Street westbound, a painted island is used by some cyclists waiting for the signal, while others wait in the lane with traffic. The inconsistent behaviour causes differing expectations and tension with drivers.

At Auditorium Avenue, there is no designated bike crossing, but many people ride within or next to the crosswalk, and use the sidewalk on each end, creating a de facto multimodal pathway crossing between Riversdale and Midtown Plaza, despite no pathway existing. On Auditorium Avenue itself, biking southbound from TCU Place is illegal, as it would be for a driver, since it's a one-way street. There is no direct legal connection within the study area from TCU Place and the YMCA to Riversdale. Similarly, there is no direct legal connection within the study area northbound from Avenue A to Idylwyld Drive, except to make the connection illegally on the sidewalk.

1.4 CONDITIONS FOR PEOPLE USING TRANSIT

There are currently no bus stops along Idylwyld Drive within the study corridor. There are bus stops, however, adjacent to the study area on 20th Street, 22nd Street, 23rd Street, 25th Street, and just north of the study boundary on Idylwyld Drive itself. A future bus rapid transit station is also planned on 22nd Street near the intersection with Idylwyld Drive.

Within the study area, transit users would be either walking, riding a bicycle, or using a wheelchair to access a bus stop. Conditions for transit users are therefore better described in the discussions relating to these modes of travel.

1.5 CONDITIONS FOR FREIGHT TRUCKS

Saskatoon has two classifications of freight truck route: Long Haul Vehicle Routes accommodate all legal freight truck sizes including multiple-trailer trucks, while Pick Up and Delivery Vehicle Routes accommodate single-unit and single-trailer freight trucks. In addition to the truck routes, freight trucks making local deliveries must use designated Arterial Road Network links to travel to and from their destination if the destination is off a designated truck route. The Central Business District has additional freight truck usage regulations, prohibiting certain trucks during the daytime.

Since the completion of Circle Drive South, Idylwyld Drive is no longer part of the Long Haul Vehicle Route. It does remain, however, part of the Pick Up and Delivery Network, and is a designated route for freight trucks with an origin or destination within the city. In addition to Idylwyld Drive itself, 22nd Street West is part of the Pickup and Delivery Network, while 20th Street, 22nd Street East, and 25th Street East are part of the Arterial Road network.

In addition to general freight truck traffic passing through the study area, two destinations were identified by stakeholders as requiring freight truck access: the joint-use loading dock for TCU Place and Midtown Plaza on Auditorium Avenue, and two businesses on the 300-block of Avenue A South.

TCU Place and Midtown Plaza share a loading dock area along Auditorium Avenue, as shown in Figure 1-13 (Image: Google). For the TCU Place loading dock in particular, trucks must face south to back into the south-facing backstage loading dock. Since Auditorium Avenue is restricted to northbound traffic only, and there is not sufficient space to turn around on site, large trucks are forced to drive the wrong way on Auditorium Avenue from 22nd Street to access the loading dock.

Figure 1-13
TCU Place and Midtown Plaza Loading Docks

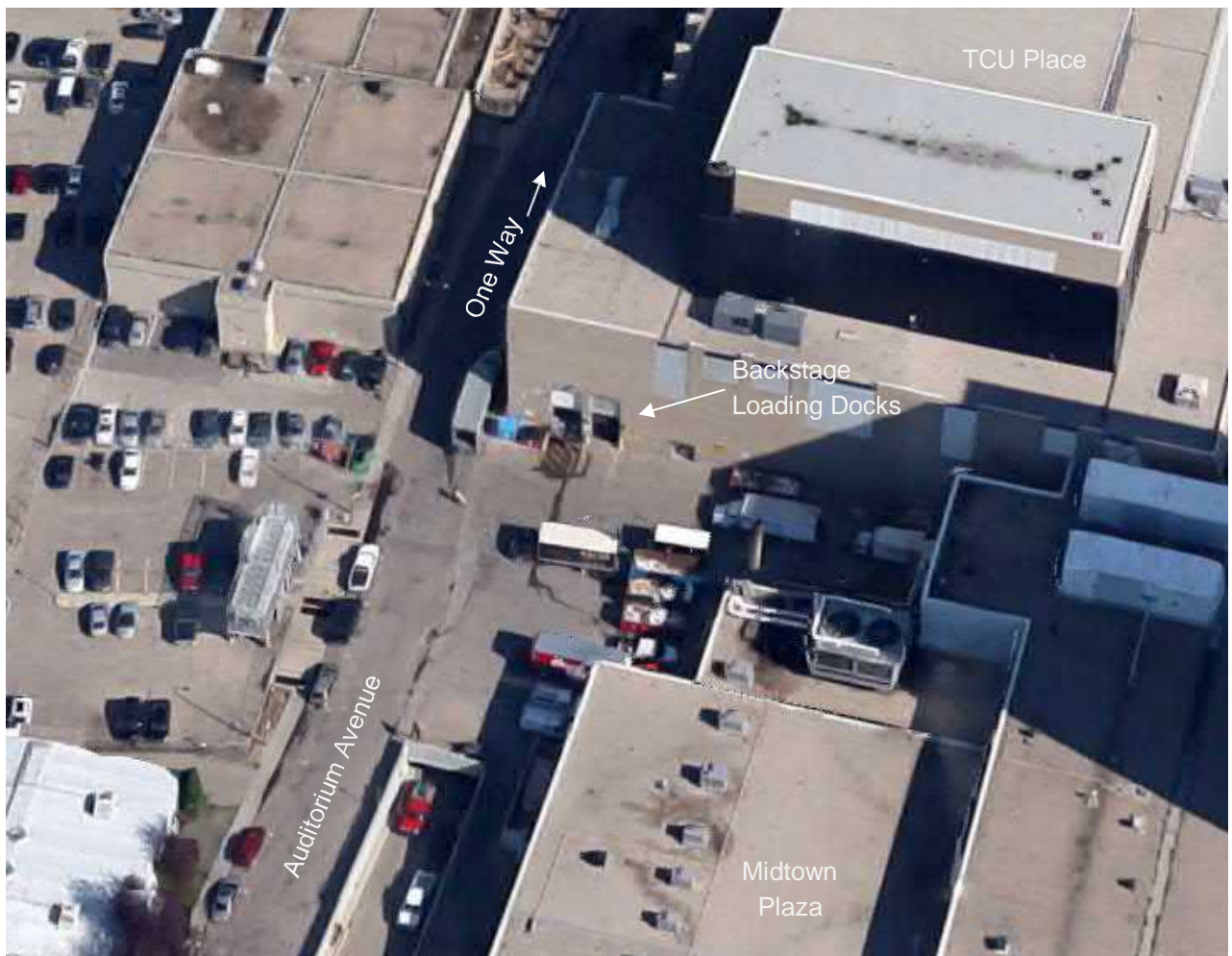

Owners of two businesses on the 300-block of Avenue A South have identified the need for freight truck access for their business operations. Currently, trucks access Avenue A using the off-ramp from Idylwyld Drive. Access to Avenue A from the south via 19th Street is not practical, since on departure, the north-facing freight truck would be required to turn left into the alley, as shown in Figure 1-10, where turning clearance for large vehicles is not available.

2 Improvement Options

2.1 ENGINEERING STANDARDS OF CARE

The following standards of care will guide the project:

- All modes of travel must be considered and accommodated: This includes Walking, Cycling, Driving, Transit, and Freight.
- All types of people must be considered and accommodated: This includes children, able-bodied adults, seniors, wheelchair users, visually impaired, hearing impaired.
- Idylwyld will be designed as an urban street: Grade separations (overpasses and underpasses) will not be considered. The street will be designed to be safe and to encourage driving speeds around the speed limit of 50 km/h.
- Idylwyld will remain an arterial street: it will be designed for the safe and efficient movement of large volumes of cars and trucks as a key link in the city's motor vehicle transportation network.
- Land use and transportation planning are integrated. The street design will be compatible with the intended land use, not the other way around. The intended land use will be determined through this study process.
- Existing businesses and driveways will be accommodated. There is no intent to force anyone out – but over the long term the access to adjacent properties may evolve along with the land use.
- Saskatoon is a winter city. Winter weather and snow management will be considered in the street design.
- The most up-to-date engineering design standards, guidelines, and best practices will be used. Modern guidelines allow a great deal of context-sensitive approaches. Idylwyld is not a suitable context for pioneering street design elements never before used or researched for use in Canada.

2.2 TECHNICAL REFERENCE PUBLICATIONS

Many technical publications will be used as references to guide the selection of design parameters. In general, publications from the Transportation Association of Canada (TAC), the Institute of Transportation Engineers (ITE), the Transportation Research Board (TRB) and the National Association of City Transportation Officials (NACTO) will be used for reference. The City of Saskatoon *New Neighbourhood & Development Standards Manual (DSM)* will not generally be used for reference as it is not intended for the context of retrofitting existing streets in a city centre environment. Reference material more than ten years old will be considered less relevant than more current publications, as there have been significant advances in engineering best practices for multimodal urban street design in that time.

Of particular note, the current edition of the *Geometric Design Guide for Canadian Roads (GDG)* was published in 1999. A new edition is available in draft form that contains changes to arterial street design guidance, notably lane width. When approved, this edition will supersede the 1999 edition. To ensure modern best practices are followed, where design parameters differ between the 1999 GDG and the 2016 Draft GDG, the more recent publication will be given more weight, and other relevant publications will be consulted before selecting a design parameter.

The following publications will be used for the project:

- Geometric Design Guide for Canadian Roads (TAC, 2016 Draft)
- Geometric Design Guide for Canadian Roads (TAC, 1999)
- Designing Walkable Urban Thoroughfares: A Context Sensitive Approach (ITE, 2010)
- Urban Street Design Guide (NACTO, 2013)
- Canadian Capacity Guide for Signalized Intersections, 3rd Edition (TAC and ITE, 2008)
- Highway Capacity Manual (TRB, 2010)
- Bikeway Traffic Control Guidelines for Canada, 2nd Edition (TAC, 2012)
- Pedestrian Crossing Control Guide (TAC, 2012)

2.2.1 Note on Units of Measure

Where a publication is produced in imperial units, the conversion to metric is assumed to represent the nearest rounded number that would be used in practice: for example, a speed expressed as 30 mph is assumed to have an equivalent meaning as 50 km/h, and not its more exact conversion of 48.27 km/h. Lane widths of 10 ft, 11 ft, and 12 ft commonly used in the United States are assumed to be equivalent to 3.0 m, 3.3 m, and 3.6 m in Canada.

2.3 MEASURES OF EFFECTIVENESS

Table 2-1 lists the measures of effectiveness that will be used to evaluate alternatives in subsequent phases of this project. The measures are intended to be comparison-based, with score or rankings assigned to each alternative based on its relative strength in achieving each measure.

**Table 2-1
Measures of Effectiveness**

Target User Group	Measures of Effectiveness
All	Compliance with Engineering Standards of Care
	Congruity with public and stakeholder input
	Compatibility with other plans
People Driving	Corridor travel time
	Lane continuity
	Intersection delay
	Lane/movement delay
	Queue length
	Accessibility for freight trucks (where applicable)
People Walking and Using Wheelchairs	Sidewalk space
	Lateral separation from motor vehicle traffic
	Crosswalk length
	Maximum wait time at intersections
	Curb radius (proxy for conflicting traffic speed)
	Directness of connections between destinations including transit stops
People Riding Bicycles	Facility type
	Lateral separation from motor vehicle traffic
	Intersection accommodation type
	Maximum wait time at intersections
	Directness of connections between destinations

2.4 GEOMETRIC DESIGN PARAMETERS

2.4.1 Basic Lanes and Route Continuity

The TAC *Geometric Design Guide*, 2016 Draft Section 3.6 and 1999 Edition Section 2.1.6, discuss lane balance and continuity for arterials and freeways. The 2016 Draft defines the basic number of lanes as “a minimum number of lanes designated and maintained over a significant length of route” (p. 3-91). TAC does not define “significant length”, but illustrates the concept with an image at the scale of a city, suggesting that the 900 m corridor length of the study area is less than a “significant length”. Idylwyld has four basic lanes through the rest of Saskatoon both north and south of the study area. The recommended basic number of lanes through the study area is therefore also four, to which auxiliary lanes may be added for individual locations as warranted through the study process. Auxiliary lanes in this context could be designated for turning movements, through movements, or both, but only designated auxiliary lanes would be added or terminated within the study area.

TAC also states that operational problems on higher-classification roadways are attributable to “failure to maintain route continuity” (p. 3-95) This is currently observed in the southbound direction, where the two lanes entering the study area are not continuous with the two lanes departing the study area, forcing many drivers to make a lane change to continue on the same route. A route can be defined by roadway name or number. The recommended route continuity paradigm is for the two lanes approaching the study area from the north to be continuous with the two lanes departing the study area toward the south, and vice-versa.

2.4.2 Lane Widths

The ITE *Context Sensitive Approach* (2010) states that lane widths in the range of 3.0 to 3.3 m are appropriate on arterials with target speeds below 50 km/h, but that buses require a minimum 3.3 m lane width (p. 137). It refers to publications of the American Association of State Highway and Transportation Officials (AASHTO) stating that the benefits of 3.0 to 3.3 m travel lanes include a reduction in pedestrian crossing distance and lower construction cost, with no impact to safety performance (p. 138). The ITE publication measures lane width from curb to curb where catch basins are traversable (pp.136-137).

The TAC *Geometric Design Guide* (2016 Draft) states that the minimum lane width is 3.0 m, but that 3.3 m should be used where trucks or buses are present. It further states that 3.0 m to 3.3 m is suitable for pedestrian-oriented design. The TAC publication excludes gutters from the lane width and suggests 0.25 m should be added between the lane and the curb (p. 4-9). The TAC *Geometric Design Guide* (1999 Edition) suggested lane widths of 3.5 m to 3.7 m for minor arterials (p. 2.2.2.2). It also states that for constrained retrofit projects where the speed is less than 60 km/h, these dimensions may be reduced by 0.2 m, effectively adjusting the lower end of the design domain to 3.3 m (p. 2.2.2.2). Regarding the relationship between lane width and safety, the 1999 GDG states, “the bulk of available research pertains to two-lane rural roads. Little is known about the effect of lane width on multilane or urban roadways.” (p. 2.2.2.3). While this publication remains the current approved guidance, the state of the practice since 1999 has changed significantly in regard to this design parameter, as evidenced by the guidance in the other publications.

The NACTO *Urban Street Design Guide* (2013) states lanes greater than 3.3 m may cause speeding and recommends that truck and bus routes should have one lane of 3.3 m and one lane of 3.0 m (p. 34).

For Imagine Idylwyld, the TAC 2016 Draft is recommended as primary guidance: 3.3 m for the outer lane, 3.0 m for inner lanes and turning lanes, and for the 0.25 m gutter to be excluded from the lane width. Inclusive of the gutter, the effective width of the outer lane is 3.55 m and the inner lane is 3.25 m adjacent to a median, and 3.0 m where there is no adjacent median.

Recommended lane widths are summarized in Table 2-2.

Table 2-2
Lane Width Design Parameters

Parameter	TAC 1999	TAC 2016D	ITE 2010	NACTO 2013	Imagine Idylwyld
Curb Lane Width	3.3 m – 3.7 m	3.0 m - 3.6 m	3.0 m - 3.3 m	3.0 m - 3.3 m	3.3 m
Inner Lane Width	3.3 m – 3.7 m	3.0 m - 3.6 m	3.0 m - 3.3 m	3.0 m	3.0 m
Turn Lane Width	3.0 m – 3.7 m	3.0 m - 3.3 m	3.0 m - 3.3 m	3.0 m - 3.3 m	3.0 m
Gutter Width	0.50 m	0.25 m	Included in Lane	n/a	0.25 m

2.4.3 Curb Radius and Channelization

The curb return radius affects pedestrian crossing distance, vehicular turning speeds, and navigability for large vehicles. Table 2-3 summarizes various publications' guidance and project recommendations for curb radii.

**Table 2-3
Curb Radius**

Parameter	TAC 1999	TAC 2016D	ITE 2010	NACTO 2013	Imagine Idylwyld
Curb Radius (Minimum)	Minimum design vehicle turning path (p. 2.3.4.4)	Smallest possible for design vehicle (p. 6-23)	3 – 9 m (p. 68)	3 – 4.5 m (p. 117)	7.5 m or design vehicle

All intersection design is subject to accommodating the design vehicle, which may supersede the minimum curb radius.

Channelized right turns are used where radii are large and will be avoided except at 25th Street East, where the railway crossing constrains opportunities for design changes.

2.4.4 Design Vehicle

The minimum design vehicle for all locations is a fire truck. Dimensions have been provided by the Saskatoon Fire Department. Where a bus route is present, a transit bus is also considered a design vehicle. For turns to and from 23rd Street East, an intercity bus is considered a design vehicle due to the presence of the bus station just east of the study area.

Idylwyld Drive and 22nd Street West are designated “Pickup and Delivery Routes” by the City of Saskatoon, and 20th Street West is a designated “Arterial Network” for deliveries. The WB-20 truck is considered the design vehicle for turns to and from these streets.

Turns from Idylwyld to a cross street will be accommodated without the design vehicle encroaching onto adjacent lanes on Idylwyld. For the low-volume intersections of 21st Street W and 23rd Street W, the design vehicle will be permitted to use the full pavement width, including encroaching on the opposing lanes on the minor street. In other locations, design vehicle turns will be accommodated without encroaching onto opposing traffic lanes on the receiving street, although encroachment onto multiple receiving lanes in the same traffic direction will be permitted.

2.4.5 Sidewalk Width

Table 2-4 summarizes the sidewalk width values provided by various publication for similar contexts, and the recommended values for this project. The Saskatoon Active Transportation Plan (June 2016) is used for guidance in addition to the other technical publications.

**Table 2-4
Sidewalk Design Parameters**

Parameter	TAC 1999	TAC 2016D	ITE 2010	NACTO 2013	Sktn ATP (2016)	Imagine Idylwyld
Total Sidewalk Width	By Context	By Context	3.6 - 4.8 m (p. 124)	By Context	n/a	Min 4.2 m
Clear Sidewalk Width	2.0 - 3.5 m (p. 3.3.2.1)	Min 1.8 m (p. 6-14)	Min 2.4 m (p. 124)	2.4 - 3.6 m (p. 38)	2.5 m (p. 42)	Min 2.5 m
Furnishing Zone	By Context	0.5 - 3.0 m (p. 6-15)	Min 1.2 m (p. 124)	Min 0.6 m (p. 40)	n/a	Min 1.2 m
Frontage Zone	0.4 - 0.9 m (p. 3.3.2.2)	0.5 - 3.0 m (p. 6-13)	0.7 m (p. 124)	By Context	n/a	Min 0.5 m

2.4.6 Note on the 25th Street Intersections

The Canadian Pacific Railway runs through the intersection of Idylwyld Drive and 25th Street East. The intersection with 25th Street West is about 30 m away. The current configuration dates to 2013 along with the extension of 25th Street from 1st Avenue to Idylwyld Drive. The geometric design of these two adjacent intersection is heavily constrained by the railway crossing and related Transport Canada and railway company requirements. As requested by the City of Saskatoon, geometric design changes to these intersections are excluded from the scope of this project. Signal timing or other non-geometric changes may be considered.

2.5 TRAFFIC SIGNAL TIMING PARAMETERS

2.5.1 Cycle Time

The CCG describes 90 s as a “typical” cycle time, with 120 s as a “practical upper limit” and longer cycle times used “under exceptional conditions” (p. 4-87). The Guide also states that cycle time should “reflect design objectives” (p. 4-88).

The NACTO guide states that “cycle lengths of 60 – 90 seconds are ideal for urban areas [to permit] frequent crossing opportunities” (p. 131)

Where pedestrian actuation is required, the cycle time also represents the maximum waiting time for pedestrians since a pedestrian calling the walk signal an instant after the start of the green phase would have to wait a full cycle for the next opportunity to cross. A primary design objective of this project is to

transform the perception of Idylwyld from a barrier to a connector. The signal cycle time is therefore a critical consideration.

The current condition of 125 to 130 s cycle time is undesirable. A target maximum of 90 s is recommended for this project.

2.5.2 Pedestrian Clearance Interval

The CCG states that pedestrian walking speed is usually 1.2 m/s or 1.0 m/s, although in “industrial areas with few pedestrians, 1.5 m/s is sometimes used.” (p. 3-70) NACTO encourages designers to assume a walking speed of 0.8 to 1.1 m/s (p. 131).

Pedestrian walking speed and clearance interval often govern the amount of green time required for minor streets. If the assumed walking speed is too low, the minor street can receive more green time than it needs for its traffic volume, decreasing green time for Idylwyld and increasing congestion. It is clear, however, that the study area is not an “industrial area with few pedestrians”.

To balance the priorities of traffic flow and pedestrian crossing accommodation, a walking speed of 1.2 m/s is recommended for use in this project.

2.5.3 Amber Interval and All-Red Period

The CCG provides guidance on amber interval selection by referencing practices in Ontario and in Edmonton, as well as research completed by ITE. For a speed of 50 km/h and a level grade, the amber interval would be 3.3 s in Ontario, 3.0 to 4.0 s in Edmonton, and 3.3 s according to ITE guidance (pp. 3-61 - 3-62). An amber interval of 3.5 s is recommended for use in this project. This would be slightly more conservative than the CCG minimum.

The all-red interval is defined in the CCG by a formula relating to the geometry of the intersection (p. 3-62). It is not the intent at this conceptual design stage to determine the all-red interval for each intersection leg to the fraction of a second, as these calculations are best suited for the subsequent detailed design phase. For planning purposes, a clearance width of 20 m was assumed. For a clearance width of 20 m, the calculated all-red interval is 1.87 s. A value of 2.0 s is recommended for this project, with two exceptions:

- 25th Street East is constrained to its existing geometry, and accordingly, red clearance intervals at this location will not be changed from their current values.
- 22nd Street is wider than 20 m, and accordingly, the current all-red interval will continue to be used for northbound and southbound signal phases.

The minimum amber and all-red intervals for left turn arrows are 3.0 s and 1.0 s, respectively (p. 3-58). These values are accordingly recommended for use in this project.

Table 2-5 summarizes the traffic signal timing parameters recommended for use in this project.

**Table 2-5
Traffic Signal Timing Parameters**

Parameter	TAC/ITE (2008)	NACTO (2013)	Imagine Idylwyld
Cycle Time	“Reflect design objectives”	60 – 90 s (p. 131)	90 s
Pedestrian Walk Speed	1.0 – 1.2 m/s (p.3-70)	0.8 – 1.1 m/s (p. 131)	1.2 m/s
All-Red Period	Min: 1.0 s Calculated: 1.9 s	n/a	2.0 s
All-Red Period (Left Turn)	1.0 s (p.3-58)	n/a	1.0 s
Amber Interval	3.3 s (p. 3-62)	n/a	3.5 s
Amber Interval (Left Turn)	3.0 s (p.3-58)	n/a	3.0 s

2.6 INITIAL CONCEPT LAYOUT

An Initial Concept Layout was prepared using the parameters established above to create a basic design concept for the motor vehicle lanes and sidewalks. As a general summary, the basic design features:

- Four basic continuous lanes through the study area.
- Auxiliary dedicated left turn lanes anywhere left turns are permitted on Idylwyld.
- Head to head opposing left turn lanes where applicable.
- Lanes either 3.0 m or 3.3 m in width.
- Sidewalks a minimum of 4.2 m in width.
- Traffic signal timing parameters as described.
- Consistent pedestrian walk time based on 1.2 m/s assumed walking speed.

Figure 2-1 and Figure 2-2 illustrate a typical cross section using the basic design parameters at midblock locations and intersections, respectively. Landscaping, cycling facilities, sidewalk amenities and other street side features are not included at this stage and will be considered in subsequent phases of the project.

Figure 2-1
 Base Concept Cross Section – Midblock

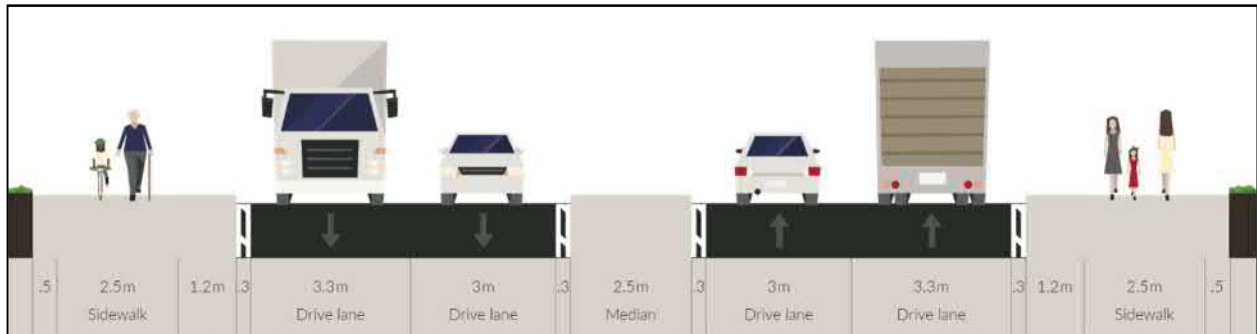
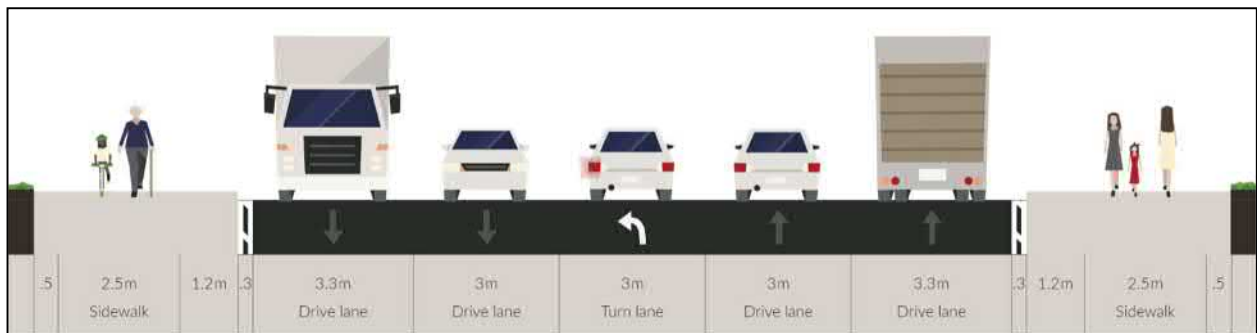

Figure 2-2
 Base Concept Cross Section – Intersections



A limited number of additional design features were also added to the basic design to create the initial concept alternative, including:

- Medians mid-block between left turn lanes and where otherwise required for traffic guidance.
- A southbound right turn auxiliary lane at the 22nd Street intersection to handle the particularly large turning volume for that movement.
- A change in the number and function of lanes on 20th Street to explore the possibility of dedicated bicycle lanes crossing Idylwyld Drive.
- Designation of the right hand lanes on 22nd Street as dedicated right turn lanes, which could become the configuration if the outer lanes are designated bus and right-turn only lanes upon implementation of the bus rapid transit system.
- A change in the number and function of lanes on 23rd Street East and Jamieson Street to accommodate a formalized connection across Idylwyld Drive between the Blairmore Bikeway and the 23rd Street protected bike lanes.
- Prohibition of northbound left turns from Idylwyld Drive to the private driveway at the 24th Street East intersection, because there was not sufficient space for a dedicated left turn lane.

Figure 2-3 illustrates the conceptual cross section with a right turn auxiliary lane added. In the initial Concept Layout, this cross section is used for the north leg (southbound right turn) at the 22nd Street intersection.

Figure 2-3
Conceptual Cross Section with Auxiliary Right Turn Lane

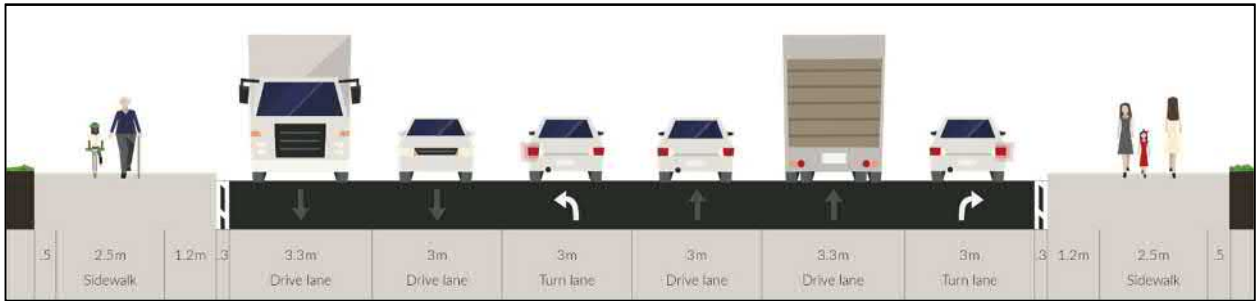

A plan drawing of the Initial Concept Layout is shown in Figure 2-4. A larger size version is found in Appendix C.

Figure 2-4
Initial Concept Layout

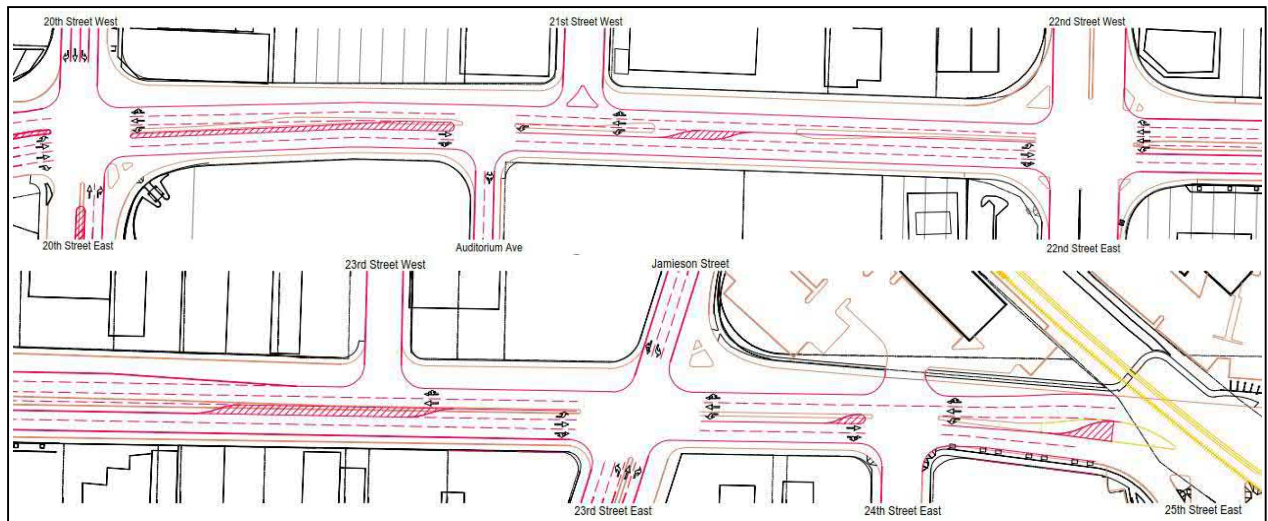

Each of the additional design features included in the Initial Concept Alternative represents a potential improvement option to be considered in more detail in subsequent phases of this project. The basic features are defined as the project standards. Alternatives that do not achieve the project standards will not be considered in subsequent phases of the project.

2.6.1 Capacity Analysis Results

Table 2-6 and Table 2-7 summarize calculated traffic conditions for the initial concept alternative in each peak hour for each signalized intersection. Measures include the volume to capacity ratio, average intersection delay, level of service. Detailed analysis results including individual lane group results are found in Appendix D.

**Table 2-6
Initial Concept Traffic Conditions, Morning Peak Hour**

Intersection	Volume / Capacity	Average Delay	Level of Service
20th Street	0.53	15 s	B
Auditorium Avenue	0.52	3 s	A
22nd Street	0.78	28 s	C
23rd Street East / Jamieson Street	0.62	17 s	B
24th Street East	0.68	10 s	B
25th Street East	0.66	12 s	B

**Table 2-7
Initial Concept Traffic Conditions, Afternoon Peak Hour**

Intersection	Volume / Capacity	Average Delay	Level of Service
20th Street	0.83	22 s	C
Auditorium Avenue	0.53	2 s	A
22nd Street	1.09	42 s	F*
23rd Street East / Jamieson Street	0.78	24 s	C
24th Street East	0.84	22 s	C
25th Street East	0.81	18 s	B

*Level of service is defined as F when volume exceeds capacity regardless of average delay.

Table 2-8 and Table 2-9 summarize the traffic conditions using traffic volumes forecast for a city population of 400,000.

**Table 2-8
Initial Concept Traffic Conditions, Morning Peak Hour, 400,000 Population**

Intersection	Volume / Capacity	Average Delay	Level of Service
20th Street	0.85	22 s	C
Auditorium Avenue	0.63	4 s	A
22nd Street	0.82	90 s	F
23rd Street East / Jamieson Street	0.81	26 s	C
24th Street East	0.80	15 s	B
25th Street East	0.94	24 s	C

**Table 2-9
Initial Concept Traffic Conditions, Afternoon Peak Hour, 400,000 Population**

Intersection	Volume / Capacity	Average Delay	Level of Service
20th Street	1.14	42 s	F*
Auditorium Avenue	0.73	7 s	A
22nd Street	1.17	72 s	F*
23rd Street East / Jamieson Street	0.94	40 s	D
24th Street East	1.03	32 s	F*
25th Street East	1.05	31 s	F*

*Level of service is defined as F when volume exceeds capacity regardless of average delay.

2.7 OTHER CONCEPTS FOR EVALUATION

Additional concepts to be evaluated in subsequent phases of the project include:

- Dual northbound left turn lane at the 22nd Street intersection.
- Various lane function options on 20th Street.
- Southbound right turn lane at the 20th Street intersection.
- Median closure at the 24th Street intersection.
- Avenue A access reconfiguration.
- Auditorium Avenue conversion to two-way street.
- Changes to signal timing and coordination.

REPORT

Appendix C – HCM 2010 Analysis: Current Configuration



REPORT

Appendix D – HCM 2010 Analysis: Recommended Configuration



Appendix E – Microsimulation Analysis



REPORT



Appendix E – Microsimulation Analysis

E.1 - PM Peak - Recommended Configuration

